

---

# CHAPTER 10

---

# ACOUSTIC EMISSION TESTING

---

## 1. HISTORY AND DEVELOPMENT

---

The word “acoustic” is derived from the Greek word *akoustikos*, which has to do with “hearing.” For centuries, the precursor to structural collapse has been sounds that are emitted prior to the failure of a supporting member. A tree branch emits a cracking sound before it actually breaks and stepping onto thin ice produces sounds that warn of impending collapse. Acoustic emission (AE) in this form is to the ears what visual inspection is to the eyes. The analysis of these emissions has become a science in itself.

Acoustic emission testing (AET) has become a recognized nondestructive test (NDT) method commonly used to detect and locate faults in mechanically loaded structures and components. AE can provide comprehensive information on the origination of a discontinuity (flaw) in a stressed component and also provides information pertaining to the development of this flaw as the component is subjected to continuous or repetitive stress.

Discontinuities in components release energy as the component is subjected to mechanical loading or stress. This energy travels in the form of high-frequency stress waves. These waves or oscillations are received with the use of sensors (transducers) that in turn convert the energy into a voltage. This voltage is electronically amplified and with the use of timing circuits is further processed as AE signal data. Analysis of the collected data comprises the characterization of the received voltage (signals) according to their source location, voltage intensity and frequency content.

The major difference between the AE method of NDT and the other NDT methods is that this method is passive, whereas the others, in a sense, are for the most part active. With ultrasonic, radiographic or the other NDT methods, the source of information is derived by creating some effect in or on the material by external application of energy or compounds. AE relies on energy that is initiated within the component or material under test.

The origination of the method is attributed to J. Kaiser in the 1950s. The sounds emitted during crack growth became an issue of scientific investigation during the 1960s. As the technology developed, AE became accepted as a NDT method. Separating the useful information from the background noise was the challenge to the instrument developers. Maturity of the technology led to the ongoing investigation into the micromechanical processes that produce these emissions within various materials.

The technology involves the use of ultrasonic sensors (20 Khz–1 Mhz) that listen for the sounds of material and structural failure. Acoustic emission frequencies are usually in the range of 150–300 kHz, which is above the frequency of audible sound. Crack growth due to hydrogen embrittlement, fatigue, stress corrosion, and creep can be detected and located with the use of this technology. High-pressure leaks can also be detected and iso-

lated. AE technology is also becoming commonly applicable to nondestructive testing for structural integrity of structures made from composite materials.

## 2. PRINCIPLES OF ACOUSTIC EMISSION TESTING

The AET process is illustrated in Figure 10-1. It begins with forces acting on a body; the resulting stress is the stimulus that causes deformation and with it, acoustic emission. The stress acts on the material and produces local plastic deformation, which is breakdown of the material at specific places. This material breakdown produces acoustic emission: an elastic wave that travels outward from the source, moving through the body until it arrives at a remote sensor. In response, the sensor produces an electrical signal, which is passed to electronic equipment for further processing.

### 2.1 Acoustic Emission Sources

#### 2.1.2 Stress

As previously mentioned, the AE process begins with stress. Stress is a familiar concept to engineering personnel. It is like an internal force field in a structure that transmits and balances the externally imposed forces (load). Depending on its directional properties, stress may be described as tensile, compressive, bending, shear, or torsion. Stress is measured in pounds per square inch (psi) (kilograms per centimeter<sup>2</sup>). To calculate stress, the force (pounds) is divided by the area that carries it (square inches).

Stress can be thought of as a three-dimensional field having different components in different directions at each point in a structure. In response to stress, the structure of the material changes in shape. This change in shape is called "strain." The material deforms elastically and if the stress is high enough, it will deform plastically as well. "Plastic" in this context means "permanent." Plastic deformation involves a permanent change in the relative positions of the atoms in the material structure. On the atomic scale, plastic defor-

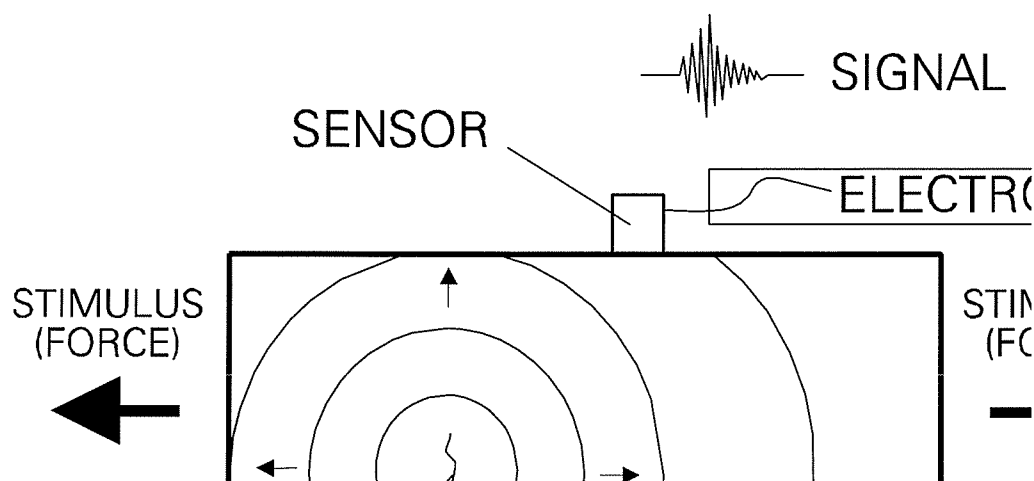

FIGURE 10-1 Schematic of the acoustic emission process.

mation involves the sliding of atomic planes over one another, through the agency of atomic-scale irregularities known as dislocations. The movement of dislocations is the microscopic mechanism that underlies the gross changes in shape that are recognized as yielding, buckling, denting, etc. Acoustic emissions that result from the movement of dislocations, or "strain," have been extensively studied with special laboratory techniques.

Other kinds of permanent deformation take place when materials break and new surfaces are created. On a microscopic scale inside a piece of steel, the materials most likely to break are specks of sulfide, oxide, and carbide, and other nonmetallic materials. The smallest of these items are the carbide "precipitates" scattered within the metal grains, for example, microscopic plates of iron carbide, only a few hundred atoms thick, distributed in "pearlite colonies." These precipitates play a big part in governing the steel's mechanical properties. On a larger scale, there are nonmetallic "inclusions" lying between the metal grains, such as manganese sulfide "stringers" formed during the rolling of the steel plate and slag inclusions introduced during welding. There may also be nonmetallic corrosion products intimately connected to the metal surface. All these nonmetallic components are less ductile than the metallic matrices in which they are embedded. As a result they break more easily when the metal is strained. The breaking of these nonmetallic components is the main source of the acoustic emission observed when crack-free metals are deformed.

When metal is cracked, there is a different kind of acoustic emission source and this one is the most important in nondestructive testing. The occurrence of a crack instantly creates a new surface. This is a major threat to a structure's integrity and is also the best-recognized source of high-amplitude acoustic emissions. Detection of emissions from growing cracks has been the most common goal in the many applications of AE technology. When a surface-breaking crack grows, the structure opens up in response to the applied forces. This is far more serious than the opening of an inclusion, which would tend to have no more than a local effect. Therefore, cracks tend to produce higher amplitude signals that are more readily detectable.

As well as causing large-amplitude AE waves as they progress, cracks produce small-amplitude AE waves from material deformation at the crack tip. Emission can also be produced from the rubbing or "fretting" of crack surfaces as they open and close and grind in response to changing loads. Corrosion products forming on the crack surfaces can enhance this emission, which make the crack even more emissive.

When material in a component deforms in response to any type of loading, the deformation tends to relieve and smooth out the local stresses. This means that after an acoustic emission event has taken place, the elastic energy stored in the stress field will have been reduced; some of it will have been released. The energy released from the stress field is used to create new deformations that will warm the material and produce the acoustic emission. Stated another way, the source of the acoustic emission energy is the energy stored in the elastic stress field produced by the loading of the structure. Acoustic emission is produced at the source, as a short pulse of elastic and kinetic energy that travels through the material as an elastic wave. The theory of frequency spectra shows that, being a short impulse, the wave carries energy at all frequencies from very low to some high upper limit, on the order of 1000 kHz and higher. Experience has shown that high sensitivity to these emissions is most easily achieved by using contact sensors in the upper part of this frequency range, between 100 kHz and 500 kHz.

Some of the lower-frequency emissions (approximately 50 Hz to 15 kHz), if they are loud enough, can be heard. This confirms the idea that the energy of acoustic emissions is spread over a very wide frequency range, and the theory that AE comprises frequencies all the way down to zero is evidenced by the largest acoustic emissions of all, earthquakes, which shake buildings a hundred miles away, at frequencies of a few hertz and

less. Finally, the lower-frequency component itself is identical to the permanent change in the stress field, created by the action of the source event.

The amount of acoustic emission energy released, and the amplitude of the resulting wave, depends on the size and the speed of the source event. A strong event produces a greater signal than will a weak event. The theory is that emission amplitude is proportional to the area of the new surface created. A sudden, discrete, crack event will produce a greater signal than will a slow, creeping advance of the crack tip over the same distance. The theory is that emission amplitude is proportional to the crack velocity.

The association between acoustic emission and crack growth has been intensively studied. Processes involving some form of embrittlement, such as hydrogen-induced cracking and stress corrosion cracking, are generally among the better emitters. Ductile processes such as slow fibrous fracture are generally quieter. Weldments are more emissive than parent metal because they are by nature less ductile.

It is useful to distinguish the three different classes of source activity:

1. Primary activity from new, permanent changes in the originally fabricated material. This is typically due to local stresses that are higher than the original stress levels.
2. Secondary activity from materials that were not part of the original fabrication, such as corrosion products.
3. Secondary activities from repetitive processes such as crack surface rubbing (friction) that do not produce new, permanent changes in the material. Secondary activity can be either helpful or a nuisance, depending on the way it is treated. Secondary emission is different from "noise," which is always a nuisance to the AE practitioner.

Noise in AE testing means any unwanted signal and is a major issue in acoustic emission technology. The main types of acoustic noise sources are friction and impact, which can result from many environmental causes. Frictional sources are stimulated by structural loading, which causes movement at movable connectors or loose bolts. Impact sources include rain, wind-driven dust, and flying objects. An intrinsic part of the AE test technique is the ability to eliminate all these noise sources and to focus on what is relevant. Noise is addressed in three ways: (1) by selecting an appropriate test strategy and instrumentation setup; (2) by taking practical precautions on site to prevent noise sources as far as possible; (3) by recognizing and removing noise indications from the recorded data. This last process is the domain of data interpretation.

## 2.2 Structural Loading and AE Source Activity

Acoustic emissions occur at locations where the local stress is high enough to cause new, permanent deformation. This often happens at stress concentrations, regions where the stress is raised by local geometry. Stress concentrations exist at weld details, changes in section, and structural discontinuities in general; they also exist around cracks and flaws. The stress concentrations at weld details are the reason why fatigue cracks initiate at these locations.

When a material deforms and emits energy, the deformation tends to relieve the high local stresses. Often the load is transferred to some other part of the structure. This has a stabilizing effect. If the structure is unloaded and then reloaded to the same level, the regions that deformed the first time will tend to be stable the second time. Thus, the emission sources will tend not to reemit the second time around, unless the load exceeds the previous maximum.

When a material is loaded (stressed) it changes shape: it stretches, compresses, or shears. The technical term for this change in shape is "strain." The strain has an elastic,

reversible component and also (if the load is high enough) a plastic, permanent component.

The elastic component of the strain occurs immediately after the load is applied. The stress/strain field inside the material is quickly redistributed such that all the forces are balanced. Actually, this redistribution takes place at the speed of sound, through the propagation of elastic waves. This is why a body vibrates if a shock force is suddenly applied.

Unlike the elastic component, the plastic component of the strain often takes considerable time to develop. Some of the deformation is immediate but some of it is delayed. Delayed deformation of nonmetallic materials is quite familiar. In time, plastics creep and stretch and wooden beams sag. Steel shows only a trace of this kind of behavior, but acoustic emission is a very sensitive indicator and will often reveal time-dependent behavior that would otherwise go unnoticed.

Figure 10-2 illustrates the characteristic behavior pattern of a newly fabricated component. In this figure, load and AE are both plotted against time. The load is raised and held, then raised and held again. AE is generated during both load rises. During the first load hold, there is no emission. But during the second load hold, the stress is higher. The emission continues for some time into the second hold period, and then the component eventually stabilizes.

Emission that continues during load holds is likely to indicate structurally significant defects. Many test procedures place particular emphasis on emission during load holds. Emission that occurs during rising load on previously unloaded structures is less easy to interpret; it may result from discontinuities. Structurally sound material will also produce emissions while the stress is increased during initial loading. The interpretation of emission during load holds is easier. Another characteristic of structurally significant defects is that they tend to emit on a second loading. If a second loading is carefully monitored, one often sees a little emission before the previous maximum load; not nearly as much as the first time, but not zero either. This emission can be an important indicator of structural instability.

As can be observed in Figure 10-3, emission is plotted directly against load. In this scenario, the load is raised, lowered, raised again to a higher level, lowered, and finally raised to a higher level still. Emission is generated during the first load rise (AB), but as the load is lowered (BC) and raised again (CB) there is no more emission until the pre-

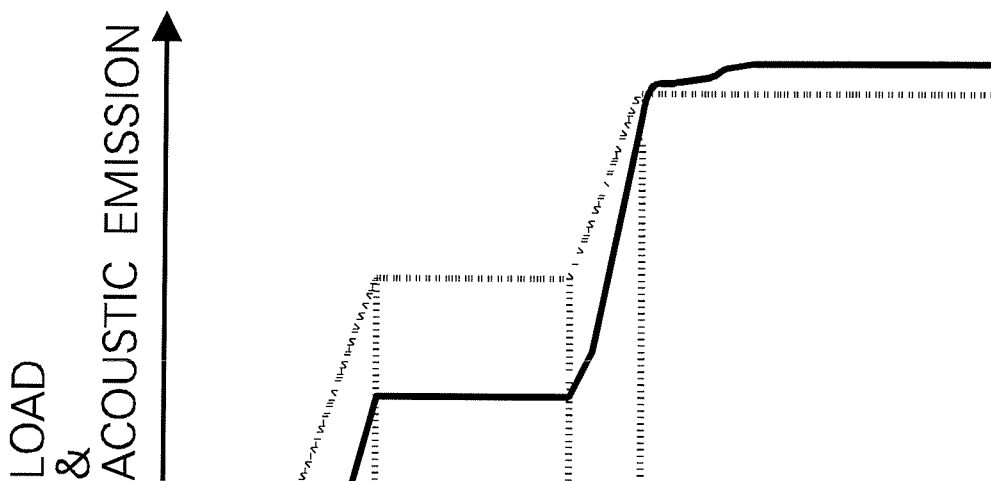

FIGURE 10-2 Emission continuing during load hold indicates instability.

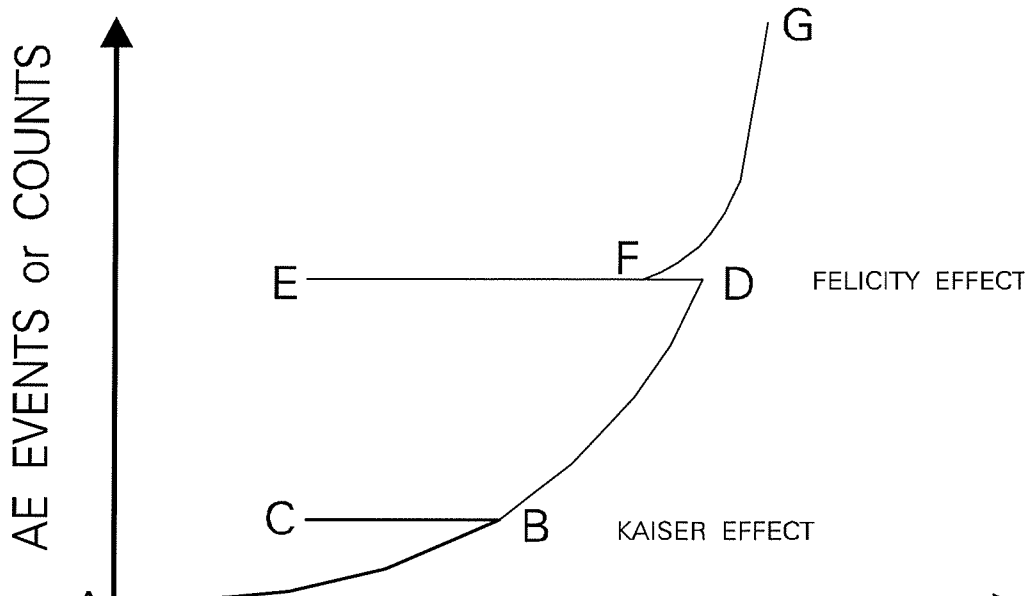

FIGURE 10-3 Emission on repeated loading.

vious load maximum is exceeded. Emission continues as the load is raised further (BD), and stops as the load is lowered for the second time (DE). On raising the load for the last time, a different emission pattern is observed: the emission starts up before the previous maximum load is attained (F). Emission continues as the load is increased (FG). The behavior observed at point B (no emission until previous maximum load is exceeded) is known as the Kaiser effect. The behavior observed at point F (emission at a load below the previous maximum) is known as the Felicity effect. Insignificant flaws tend to show the Kaiser effect while structurally significant flaws tend to show the Felicity effect.

Of special interest is the AE monitoring of structural fatigue. The emission behavior of growing fatigue cracks has been extensively studied. Classic laboratory data is shown in Figure 10-4. This diagram shows both the crack length and the accumulated total of the emission detected. The emission began with crack initiation, and then tracked rather closely with the growth of the crack, increasing as the crack propagated more rapidly toward failure.

The experiment to prove this was carried out with cyclic loading using a fixed load amplitude. It was found that the primary emission from active crack growth occurred only at the peak load levels. In fact, Figure 10-4 shows only the emission that occurred at the peak load levels; secondary emission and noise that occurred at lower load levels were outside the gate threshold level. At first, when the crack was still small, not every cycle produced emissions. However, as the crack approached the critical length for unstable propagation, every cycle produced emissions. This result fits well with the behavior of statically loaded specimens discussed above, in that insignificant flaws tend to show the Kaiser effect, whereas structurally significant flaws tend to show the Felicity effect.

The primary emission from growing fatigue cracks can result from two sources. First, there may be emissive particles, typically nonmetallic inclusions, in the stress-concentrat-

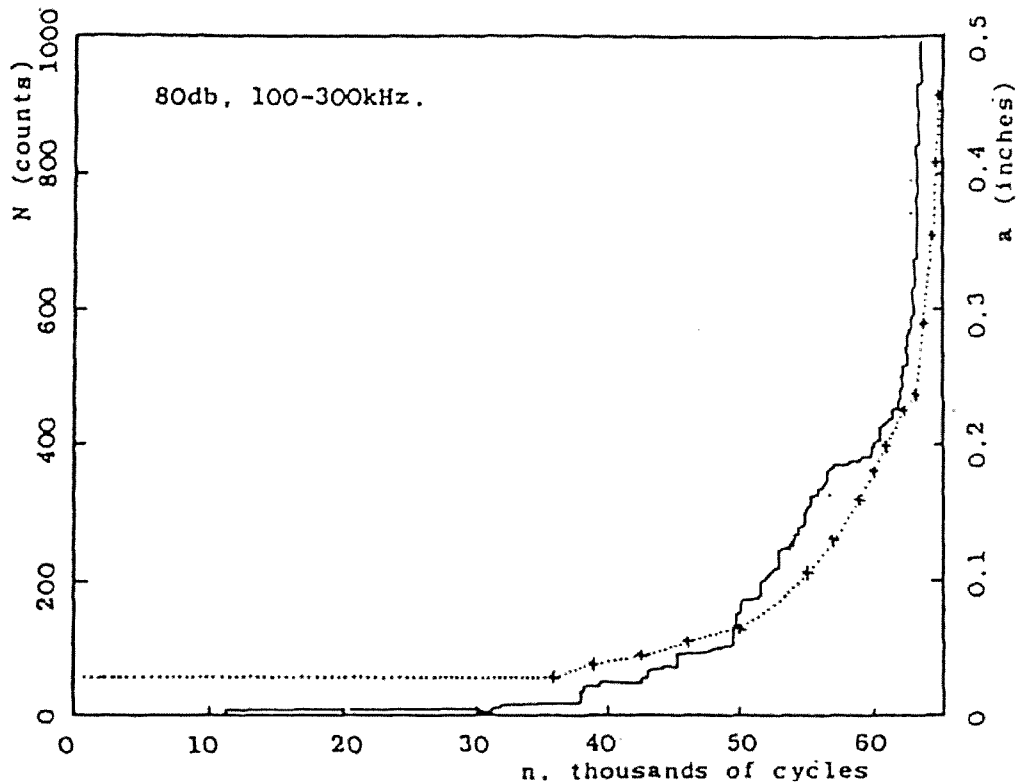

FIGURE 10-4 AE growing from fatigue crack.

ed region near the crack tip. As the crack advances toward these particles, the local stress levels rise, and their breaking will produce a primary emission. The other source is the movement of the crack tip itself. Crack tip movement is typically taking place in a mixed mode: some of the new surface is created by dislocation activity and some of it is created by small-scale cleavage, a sudden separation of the material in a region of local weakness and/or exceptionally high stress. Crack tip movement by dislocation activity is typically not detectable, but cleavage is an abrupt and relatively gross mechanism that produces plenty of AE energy in the normally detectable range.

Secondary activity from crack face friction is also often observed in AE monitoring of fatigue cracks. In constant-cycle fatigue, this activity often produces just the same signal, cycle after cycle, at intermediate load levels. This secondary emission may continue for hundreds or thousands of cycles, then die out only to start again later in the test. The best explanation is that rubbing at rough spots or "asperities" on the crack surface, as indicated in Figure 10-5, produces this. It has also been suggested that the recently created surfaces at the crack tip may stick together then break apart again as the crack tip opens and closes.

Theoretical relationships between AE and crack propagation rates have been developed. Extensive research work has been done on AE from constant-cycle fatigue; however, less work has been done relating to the random-cycle fatigue. Distinguishing between primary and secondary emission is easy in the case of constant-cycle fatigue. In the case of random-cycle fatigue it is not so easy. Crack face movement, either due to friction or to fresh growth, is an undesirable and probably deteriorating condition in the material that should be corrected.

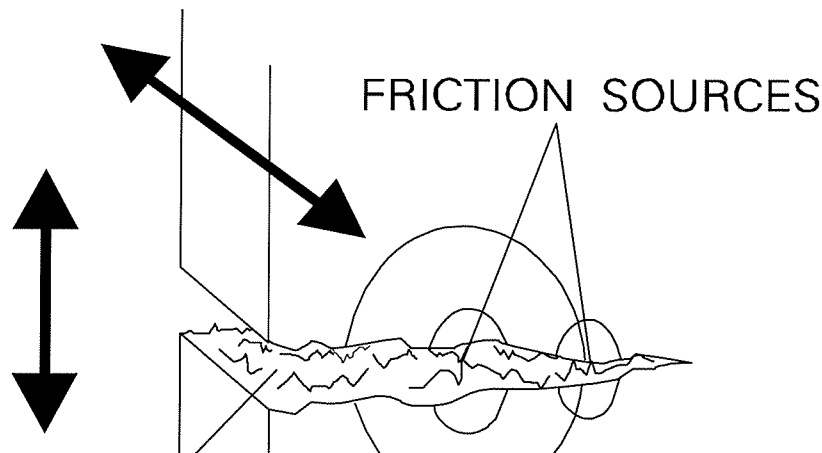

FIGURE 10-5 Crack face rubbing can produce secondary emission.

### 2.3 The Signal Shaping Chain

The signal shaping chain is shown in Figure 10-6. It has four links: the source, the propagation of the wave, the sensor, and the signal-conditioning electronics. Each link has a controlling influence on the size and shape of the measured signal. The final signal is drastically different in shape from the original motion at the source. An important consideration in discussing the signal shaping chain is the frequency content. All signals can be analyzed as to their “sine wave” frequency components. This is the field of “Fourier” analysis, one of the most powerful tools in the science and technology of signal processing.

The term “frequency” refers to the repetition rate of an oscillation within a given time period, i.e., the number of cycles per second. Anyone who has turned the knob to tune in a car radio has been selecting the frequency that he or she wants to receive. Each radio station broadcasts at a particular frequency. By turning to a station, the receiver becomes sensitive to the desired frequency. An acoustic emission source, however, is not like a radio station radiating just one frequency. It is more like a lightning bolt! When listening to a radio during a thunderstorm, the radio will pick up the lightning discharge anywhere on the AM band. This is known as a “broadband” signal, in contrast with the “narrow band” radio station. Like lightning, the impulsive acoustic emission source radiates energy at many frequencies.

From the fact that the source is broadband and radiating a variety of frequencies, it follows that there is a choice of frequencies to use for sensing the wave and measuring the resulting signal. This is the rationale for selecting the sensor and electronic filtering.

The frequency response of AE sensors can be either broadband or narrow band. Broadband sensors offer higher fidelity, a more faithful rendering of the actual motion of the metal surface at the sensor location; yet, in most practical AE testing, narrow band sensors are preferred. There are several reasons for this. Resonant sensors are generally more sensitive and much less expensive than the broadband types. They have the advantage of operating in a known and well-established frequency band, which can be chosen to optimize system performance when faced with wave attenuation and background noise. Broadband sensors have the potential to deliver extra information, through the use of advanced signal processing techniques; but, unfortunately, the best of this information is at the low end of the spectrum, just where the noise problems are worst. Thus, high-frequency resonant sensors are recommended for most practical structural monitoring.



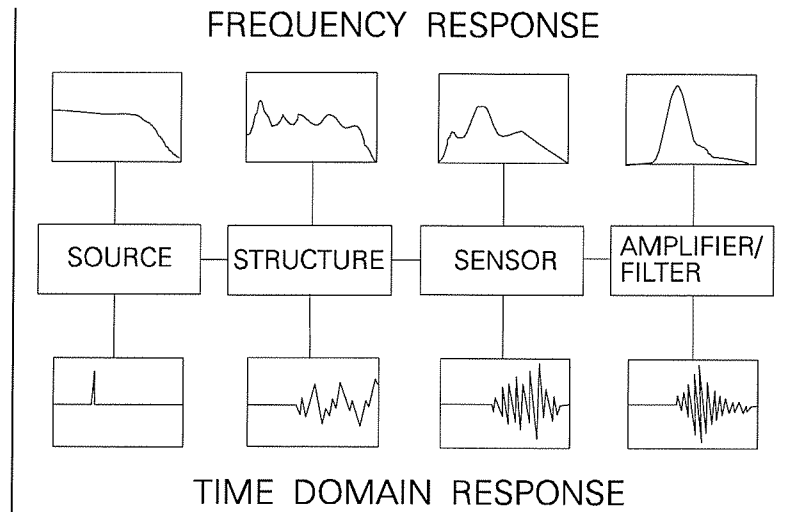

FIGURE 10-6 Signal shaping chain.

Once the resonant frequency sensor has been selected, the frequency bandpass of the amplifier/filter combination in the AE instrument is normally set to match it. Thus, the last two links of the signal shaping chain have been established. Now the signal measurements will be altered only by changes in the first two links. The same kind of source event at different locations can produce different signals; and different kinds of source events at the same location can also result in different signals. To obtain meaningful information from the AE signals, it is necessary to have made a suitable choice of sensor type and frequency filter, as well as to have a working understanding of source behavior and wave propagation effects.

## 2.4 Propagation of the AE Wave

The AE wave can be visualized by recalling the ripples produced when a stone is dropped into a pond. The ripples spread out from the source and eventually reach the banks, reflecting in a complicated pattern and ultimately dying away. Reacting to these ripples, a floating cork near the bank of the pond will bob up and down for several seconds in a complicated rhythm, even though the impact of the stone was over in a fraction of a second. The same principle applies to the propagation of AE waves. The short pulse from the source is only the beginning of the AE process. The motion at the sensor is quite unlike the original shock at the source. This is the part played by wave propagation in the signal shaping chain. The principal difference between the ripples on a pond and the AE waves in a structure is that the AE process occurs many times faster. The typical AE source motion is finished in a few millionths of a second. The wave takes perhaps a thousandth of a second to reach the sensor and it takes in the order of a hundredth of a second for the motion to die away.

Another difference between the pond and the structure is that wave propagation in a structure is generally more complex. First, the structure has many surfaces that repeatedly reflect the wave. Second, solids (unlike liquids) support shear forces as well as compressional forces. This leads to the existence of several different wave types (modes) that can all be excited simultaneously.

Aspects of the wave propagation process that are particularly important in AE technology areas are:

- Attenuation—the loss of amplitude as the wave travels outward from the source. This is important when detecting waves from distant sources.
- Wave velocity—the speed with which the disturbance travels through the structure is important for some source location techniques. In addition, signal shaping effects have a profound influence on the measured values of the detected AE signal.

#### 2.4.1 Attenuation

As the acoustic wave travels through the structure, its amplitude decreases. This effect is known as attenuation and is illustrated (for a steel plate) in Figure 10-7. In this figure, amplitude is plotted on the Y-axis using the  $\text{dB}_{\text{ae}}$  decibel scale. On this scale, each increment of 20 decibels is a tenfold increase in the signal peak voltage. The graph shows that the peak signal voltage 9 feet from the source is about one-thirtieth of the voltage very close to the source. The  $\text{dB}_{\text{ae}}$  scale is universally used and very convenient because, being logarithmic, it condenses the very wide range of AE signal amplitudes.  $\text{dB}_{\text{ae}}$  is a logarithmic measure of acoustic emission signal amplitude referenced to  $1 \mu\text{V}$ .

Attenuation is due to several factors. In most structures, the important ones are geometric spreading, scattering at structural boundaries, and absorption. When the source is only a few inches from the sensor, as in local monitoring of weld details, the geometric spreading effects are the most important. These effects are therefore especially important for crack detectability. At distances greater than a couple of feet, energy absorption and structural scattering are the most influential properties. The understanding of these effects is also important for identifying extraneous noise.

Geometric spreading effects are fundamental to wave propagation. Basically, the sound wave is “trying” to spread throughout the volume of the structure near to the source; the change in the static stress field and the wave motion are at their maximum.

In theory, for a structure that is large in all dimensions (infinite half-space), a stress

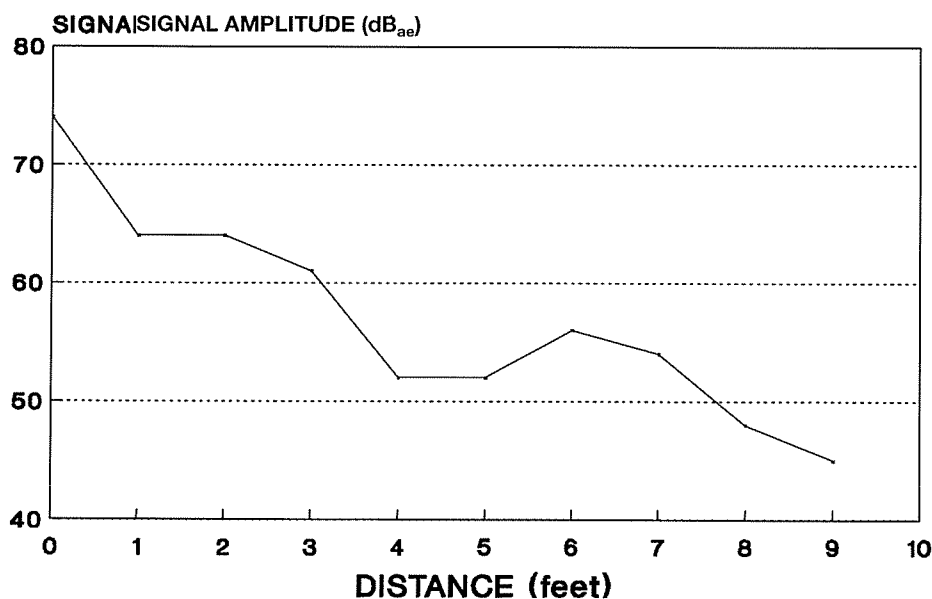

FIGURE 10-7 Attenuation amplitude decreases with distance.

wave would simply spread and continue to attenuate. In realistic structures, the boundaries force the stress wave to remain in a confined space such that attenuation from beam spreading is limited. In a small, well-defined structure such as a rod, the attenuation from geometric beam spreading is minimal and stress waves may travel great distances. The data shown in Figure 10-7 illustrate this relationship (approximately). The curve falls steeply at short distances and more gradually at larger distances. The 30% figure applies to a circular wave front spreading out in a plate-like structure such as a girder web. In a solid medium like concrete, the wave spreads out in all three dimensions and it loses amplitude more rapidly—50% for each doubling of distance. In a rod, the wave is channeled and cannot spread, so attenuation is relatively low.

The second major cause of attenuation is reflection (scatter) at structural boundaries and geometrical discontinuities. Whenever a wave meets a discontinuity, some of the wave energy is reflected. Discontinuities also produce mode conversions. These effects are especially important in the complex geometry of many structures, where there may be changes in direction, connections, stiffeners, and other boundaries along the acoustic path from source to sensor.

The third cause of attenuation is absorption. Here the elastic and kinetic energies in the wave are absorbed and converted into heat by the material through which the wave is passing. Steel absorbs very little at the frequencies used for AE testing. Nonmetallics, in general, and paint, in particular, tend to absorb energy more than steel. Absorption is greater at higher frequencies due to the shorter wavelengths at these frequencies. The distance/amplitude reduction mechanism for absorption is different from the mechanism of beam spread/amplitude reduction. In the case of distance/amplitude, there is a constant number of decibels absorption per foot from the source. This is the same at all distances from the source. For example, if there is a 6 dB reduction after the energy has traveled one foot, there will be an additional 6 dB reduction after the energy has traveled an additional foot, and so on. Thus, whereas energy losses due to beam spreading near the source are high, absorption also accounts for large losses of energy as the wave fronts move further away from the source.

Attenuation measurements are easily made with a simulated AE source. The most widely used simulated AE source is the breaking of a pencil lead pressed against a structural member, as illustrated in Figure 10-8. As the lead is pressed against the structural member, the applied force produces a local deformation that is suddenly relieved when the lead breaks. With good technique, the resulting stress wave is amazingly reproducible.

The Hsu pencil (named after the developer of the technique) and the accessory Nielsen shoe are convenient, inexpensive aids that have been enormously valuable in practical AE testing. The breaking of the lead creates a very short-duration, localized impulse that is quite similar to a natural acoustic emission source such as a crack. Furthermore, the amplitude of the lead break source is well within the range of typical crack sources. The Hsu pencil has become so well accepted as a simulated AE source, that in some procedures for wide-area monitoring, the maximum permissible sensor spacing is based on the ability to detect lead breaking from anywhere in the inspection area.

The usual procedure for developing a graph such as shown in Figure 10-7 is to break lead several times at each of several different distances from a sensor, and then to record the amplitude for each break. The amplitudes for each distance are averaged and, subsequently, the average amplitudes are plotted against distance.

The attenuation curve is an important aid in determining the sensor placements for the specific application. In many acoustic emission applications, the goal of the inspection is to monitor the entire structure. In this case, it is important that all parts of the structure are within detection range of at least one sensor. In global monitoring tests of this kind, the

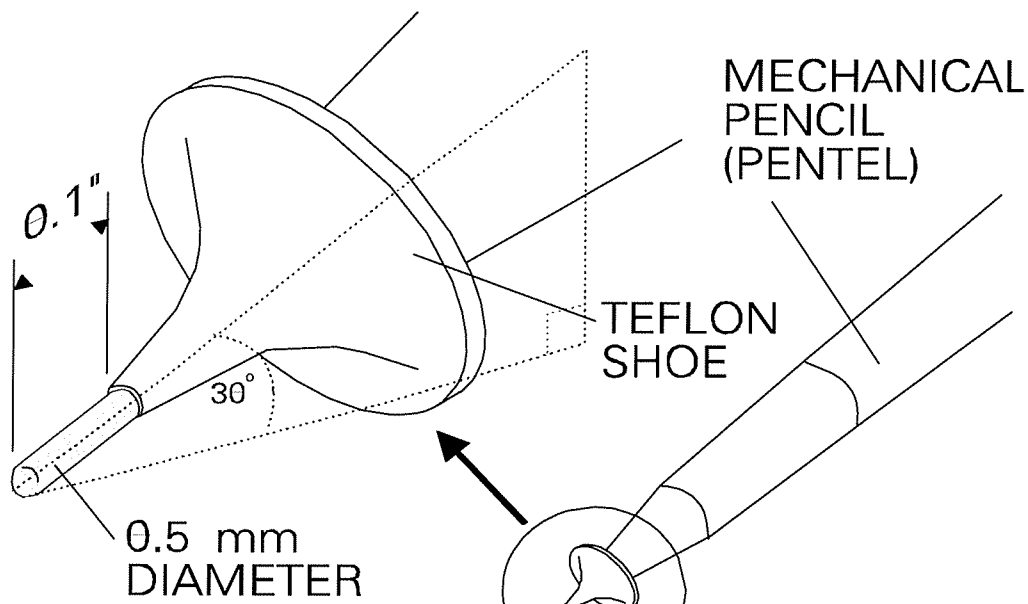

FIGURE 10-8 Hsu-Nielson source.

test procedure typically specifies how the attenuation curve can be used to determine acceptable maximum sensor spacing.

In some tests included in these guidelines, the recommended strategy is limited-area monitoring focusing on a known crack or possibly cracked site. Here the attenuation curve has different applications. It shows how sensitivity to the crack compares with the sensitivity to distant noise sources and whether distant noise sources will reach the sensor or whether they will be attenuated before reaching it. Also, it shows that sensors close to the crack must be placed at similar distances in order to get similar responses.

#### 2.4.2 Wave Velocity

Source location calculations are based on the time of arrival of the wave from the source to the sensors. These arrival times depend on the velocity with which the waves travel from source to sensor. Understanding and predicting wave velocities is an important aspect of the science of physical acoustics.

An important wave mode in AE testing of structures is the Lamb wave. This wave mode is named after Horace Lamb, an English acoustician who in the 1920s developed the mathematical theory of sine waves propagating in finite plates. This kind of theory seeks to describe wave propagation in terms of wave modes—patterns of oscillatory motion that can propagate in a stable way, maintaining their shape as they travel. In plates, Lamb identified two families of wave modes, and he developed equations that described their velocities of propagation. In the first family, the motion is symmetrical about the median plane of the plate, and in the second family it is asymmetrical. The parent members of these families are called the  $s_0$  and  $a_0$  modes respectively. The form of the motion for these modes is shown in Figure 10-9.

The  $s_0$  mode, often called the “extensional mode,” is a rippling movement in which the plate is alternately stretching and compressing in the direction of the wave motion. Coupled with this in-plane movement, the sides of the plate are “breathing” in and out symmetrically as the ripples run through the plate. To produce this kind of wave motion, the

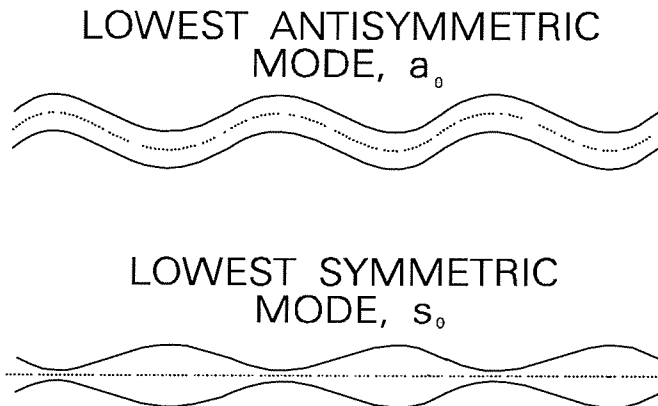

FIGURE 10-9 Basic Lamb wave modes in plates.

exciting force needs to be directed parallel to the plate. A sudden release of in-plane tension will also tend to produce this kind of wave motion.

The  $a_0$  mode, often called the “flexural mode,” is a mode in which the body of the plate bends with the two surfaces moving in the same direction. Most of the motion is transverse to the plate; there is relatively little motion in the plane of the plate. Exciting forces perpendicular to the plate produce this kind of wave motion. In addition to this, forces that are parallel to the plate but offset from the center line can produce this wave mode.

The underlying theory of elastic wave modes is the general mathematical theory of “eigenfunctions.” According to this theory, wave modes travel independently and do not interfere with one another. Several wave modes can be traveling at the same time in the same material; in this case, the motion at any point in the material is simply the sum of the motions of the various modes. The wave modes are like the raw ingredients of a recipe, which can be combined in various proportions to produce many different flavors. The two Lamb wave modes travel at different velocities. At 300–500 kHz in steel plate thicker than  $\frac{1}{4}$  inch, the  $a_0$  mode travels at 10,000–11,000 ft/sec (3000–3300 m/s). The  $s_0$  mode travels somewhat slower than 10,000 ft/sec. Thus, the  $a_0$  mode will reach the sensor a little earlier. When setting up AE source location systems, the technician usually has to enter into the computer the sensor positions and also the velocity of sound that will be used in the source location calculations. Sensor positions will usually be specified in inches, and in this case the velocity must be entered, correspondingly, in inches per second. A good practical value in AE work on many structures is 120,000 inches per second.

The  $a_0$  Lamb wave mode (flexural mode) is the most important wave mode in acoustic emission testing. It usually produces a higher amplitude wave than the  $s_0$  mode, and in typical structures it also travels faster and therefore arrives at the sensor first. Other members of the two families of Lamb waves (called  $a_1$ ,  $s_1$ , etc.) can travel faster than either the  $a_0$  or the  $s_0$  modes, but their amplitudes tend to be low and they are relatively unimportant.

Lamb waves provide the best wave propagation from the source and at distances many times greater than the plate thickness. Close to the source, i.e., within one or two plate thicknesses, it is better to think in terms of longitudinal and shear waves. These wave types are well known to technicians trained in ultrasonic testing (UT). In summary, a good knowledge of acoustic theory is the key to understanding the variables and evaluating the results of each test or situation.

### 2.4.3 Signal Shaping Effects

Wave propagation is a tremendously important stage in the signal shaping chain. It is wave propagation that largely determines the signal's size, shape, and shape-dependent signal features such as rise time and duration. Because several successful interpretive techniques are based on signal shape, it is important to have some understanding of these effects.

Figure 10-10 shows a typical record of an AE waveform recorded from a structure. Note the timescale on the X axis, running from -245 microseconds to 1.39 milliseconds (1390 microseconds), a total span of 1635 microseconds. Thus, the wave has occurred and decayed in about a thousandth of a second. In this time, there are several hundred positive and negative oscillations of the signal voltage. Some of the individual oscillations can be recognized as they stand out from the background. The dominant frequency during these oscillations is the resonant frequency of the sensor.

The waveform envelope (overall shape) shows a fast rise and a much slower decay. This is typical of AE signals. The waveform at the start of the time base is from direct waves from the source; the later part of the time base comprises waves that have been reflected back and forth many times before arriving at the sensor. The rising part of the time base is determined by strong reflections from nearby surfaces. The falling part of the timebase is shaped by more remote reflectors and by the acoustic damping in the structure.

## 2.5 Sensing and Measurement

### 2.5.1 Sensor Performance and Calibration

Secondary to wave propagation, the next essential stage in the signal shaping chain is the sensor. For sensing AE waves, piezoelectric crystals are used. The Greek word *piezein* means "to squeeze." Piezoelectric materials generate an electrical voltage and a corresponding separation of charge when they are squeezed (deformed). In the AE sensor, the

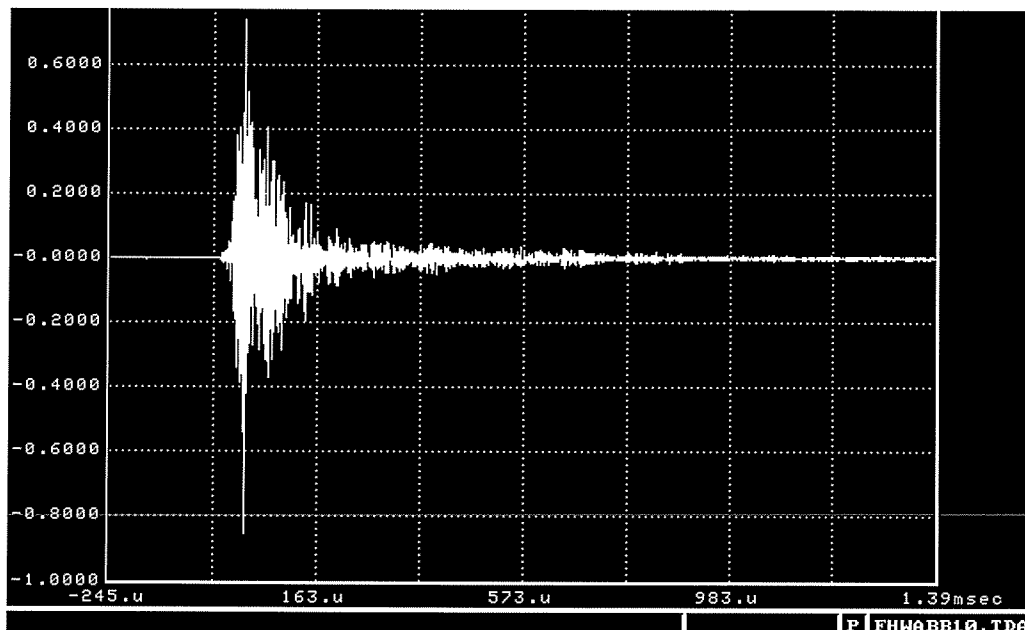

FIGURE 10-10 Typical AE waveform in a structure.

deformation is produced by motion; it is the elastic response of the piezoelectric crystal when it is struck by the incoming stress wave. The piezoelectric element is mounted inside the sensor enclosure, as illustrated in Figure 10-11. The electric voltage is generated by the element material itself. The element does not need an external power supply.

When struck by a sudden impulse, a piezoelectric element will vibrate like a bell, "ringing" at its resonant frequency. In fact, there may be many resonant frequencies all excited together. If shaken by a vibratory motion, a piezoelectric element will produce a corresponding oscillating voltage at the same frequency as the motion. The element has a linear response; if the input motion is doubled, the output voltage will also double.

The ratio (output voltage amplitude)/(input motion amplitude) is a measure of the sensitivity of the sensor. It has been established that this sensitivity depends strongly on the frequency of the motion (i.e., the number of oscillations per second). The sensitivity of the element is greatest at its resonant frequency.

Sensor calibration curves show how sensor sensitivity varies with frequency. An example is shown in Figure 10-12. The shapes of these curves are characteristic of the sensor type and vary widely in their sensitivity and frequency response. For a given sensor type, the calibration curves of individual sensors should be closely matched.

With calibration curves such as that shown in Figure 10-12, the amplitude of the input motion may be specified in units of displacement, velocity (meters per second), or pressure (microbars). In all cases, it refers to the amplitude of a sinusoidal oscillation at the frequency indicated on the X axis.

Calibration curves often have their Y axis (sensitivity) scaled in decibels (dB). Decibels are a relative measure: each decibel corresponds to an increase of 12.2%. Compounding upward, with each decibel being a 12.2% increase, it is easy to show that 6 dB is a doubling and 20 dB is a tenfold increase in sensitivity.

The sensitivity curves on sensor calibration certificates have their Y axis labeled in decibels relative to a stated reference level, such as 1 volt per meter/second. That is, zero dB means a sensitivity of 1 volt per meter/second. As shown on the graph in Figure 10-12, 6dB equals a sensitivity of 2 Volts per meter/second, and so on. Mathematically, the formula is:

$$dB = 20 \log (S/S_{ref})$$

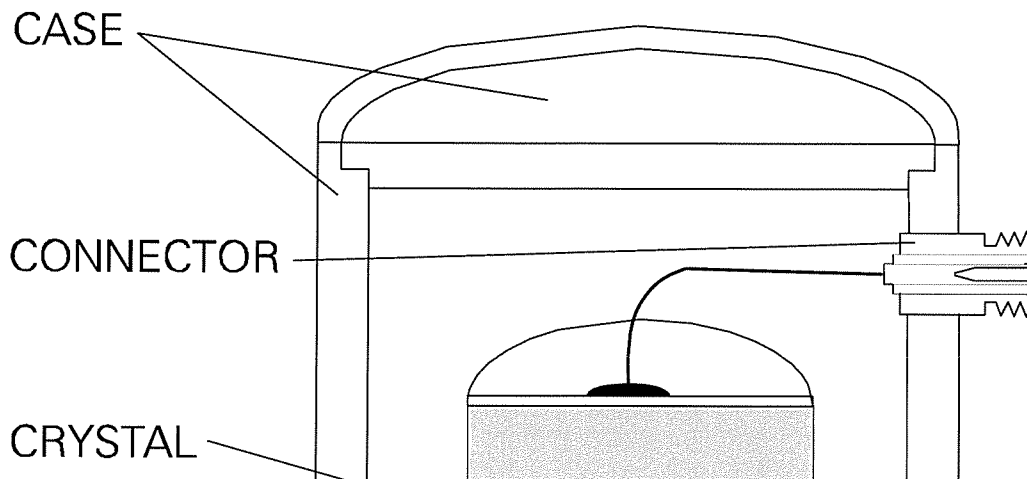

FIGURE 10-11 AE sensor schematic.

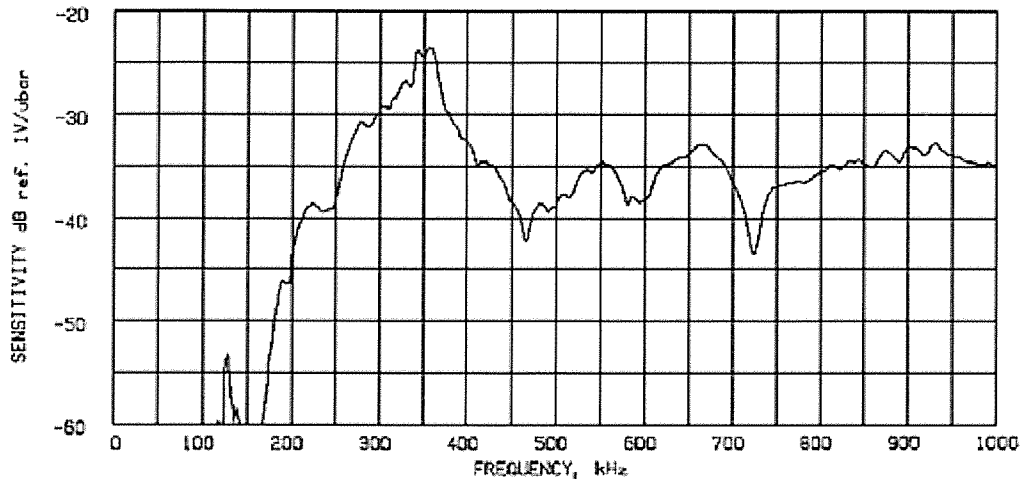

FIGURE 10-12 Typical sensor calibration curve.

where  $S$  is the sensitivity and  $S_{\text{ref}}$  the reference level, both stated in volts per meter/second.

The sensitivity of the sensor depends not only on frequency, but also on the direction of the motion. Unlike accelerometers, which are carefully designed to measure only the component of motion parallel to their axis, AE sensors respond to motion in any direction. Therefore, to understand fully the significance of a sensor calibration curve it is necessary to know about the type and direction of the wave that is being used for the calibration.

In the design of AE sensors for nondestructive testing, the manufacturer's priorities are high sensitivity, well-defined and consistent frequency response, robust performance in the working environment, and immunity to unwanted noise. Unwanted noise can also include electromagnetic interference originating from radio stations, navigation systems, etc. Immunity from this kind of noise was greatly improved with the development of the integral preamp sensor. This type of sensor has a preamplifier built into the housing along with the piezoelectric element. For field testing, it has considerable advantages over earlier sensor types, which required separate preamplifiers to be mounted within a few feet of the sensor.

The sensor must be in good acoustic contact with the structure under test so that it will detect the motion of the AE wave and deliver a strong signal. Coupling and mounting techniques are very important. An acoustic couplant in the form of an adhesive, a viscous liquid, or grease is applied to the sensor face and the sensor is pressed against the structure. The surface on which the sensor is mounted must be smooth and clean; some preparation may be necessary. The sensor must be securely held in place with adhesive, magnetic hold-down, or other means. After mounting, the system performance is verified by simulating an AE signal and checking the system response.

### 2.5.2 Signal Conditioning, Detection, and the Hit Process

The signal produced by the sensor is amplified and filtered, detected and measured. Amplifiers boost the signal voltage to bring it to a level that is optimum for the measurement circuitry. Along with several stages of amplification, frequency filters are incorporated into the AE instrument. These filters define the frequency range to be used and attenuate low-frequency background noise. These processes of amplification and filtering are



called “signal conditioning.” They “clean” the signal and prepare it for the detection and measurement process (evaluation).

After conditioning, the signal is sent to the detection circuit. This is an electronic comparator, a simple circuit that compares the amplified signal with an operator-defined threshold voltage. The principle is illustrated in Figure 10-13.

Whenever the signal voltage rises above the threshold voltage, the comparator generates a digital pulse. The first pulse produced by the comparator marks the start of the “hit.” This pulse is used to trigger the signal measurement process. As the signal continues to oscillate above and below the threshold level, the comparator generates additional pulses. While this is happening, electronic circuits are actively measuring several key features of the signal. In time, the amplitude of the signals reduce to a point where there are no more threshold crossings. After the predetermined time (the “hit definition time”) has passed without any further pulses from the comparator, the system determines that the event has ended. The hit process is then brought to a close. Control circuitry terminates the measurement process and passes the results to a microprocessor. Finally, the measurement circuitry is reset and rearmed ready for the next event.

### 2.5.3 Signal Features and Their Measurement

Measurements are made of the relevant features of the signal such as the amplitude, duration, signal energy, and counts. These features and their relationship to the detection threshold are shown in Figure 10-14. This diagram shows a typical AE signal as a voltage–time curve, just as it would appear on an oscilloscope screen. A typical signal lasts less than a thousandth of a second.

“Amplitude”, in AE testing, refers to the largest voltage present in the signal waveform. It is one of the most important measures of signal height. It is fundamental because for a signal to be detected, its amplitude must exceed a predetermined threshold. Amplitude is usually measured in  $\text{dB}_{\text{ae}}$ , a decibel scale running from 0 to 100. 0  $\text{dB}_{\text{ae}}$  is defined as an amplitude of one microvolt at the preamplifier input.

“Duration” is the length of time from the first threshold crossing to the last, measured in microseconds (millionths of a second). The relationship between duration and amplitude tells the user about the signal’s shape: whether it is a short sharp “click,” or a long drawn-out “scrape.”

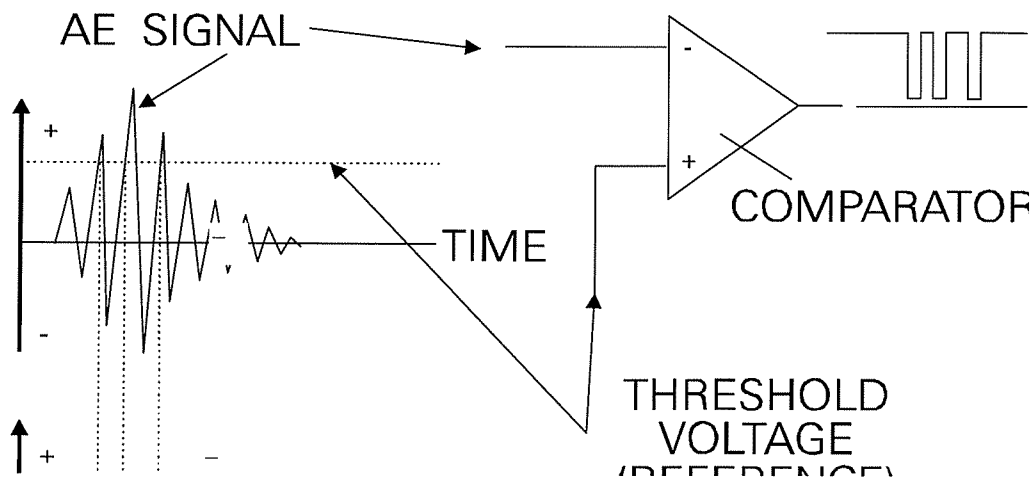

FIGURE 10-13 Signal detection by comparison with threshold.

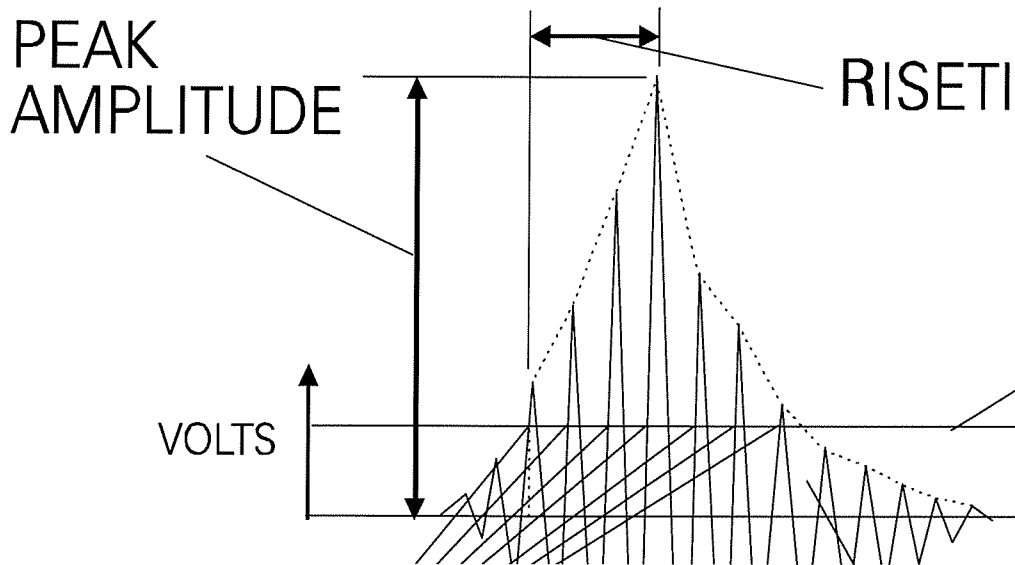

FIGURE 10-14 Key signal features.

“Signal energy” is the area under the voltage–time envelope, i.e., the area under the dotted line shown in Figure 10-14. This is another important measure of signal size and is the most widely used measure of AE activity. When a structure produces many emissions in response to loading, the energies of the individual signals can be added to produce a total amplitude. Of all the techniques that have been used to describe emission quantity in a single number, this has been the most successful.

“Counts” are the comparator output pulses corresponding to the threshold crossings. A single hit may provide only a few counts or it might furnish hundreds of counts, depending on the size and shape of the signal. For the electronics designer, this is the easiest measurement to make, and in the early years of AE, “counts” were the most common way to describe and report AE quantities. During the 1980s, energy replaced counts as the preferred measure of AE activity. However, counts are still useful for data interpretation; used in conjunction with amplitude or duration, they can give valuable information on signal shape.

Several other signal features may be measurable, depending on the equipment available, but those noted above are the most widely used. A block diagram for typical instrumentation used for making these measurements is shown in Figure 10-15.

As well as measuring the features of the individual signals, the AE instrument usually measures also the times at which they are detected and the environmental variables that may be causing the activity. The broader aspect of instrument architecture is discussed in the next section.

## 2.6 Instrument Architecture

The most common overall design for AE instruments is the so-called “hit-based” architecture. Typical AE activity consists of a series of distinct signals. These signals occur at irregular time intervals and have widely varying shapes and sizes. Hit-based architecture is designed for the efficient measurement and recording of this kind of activity.

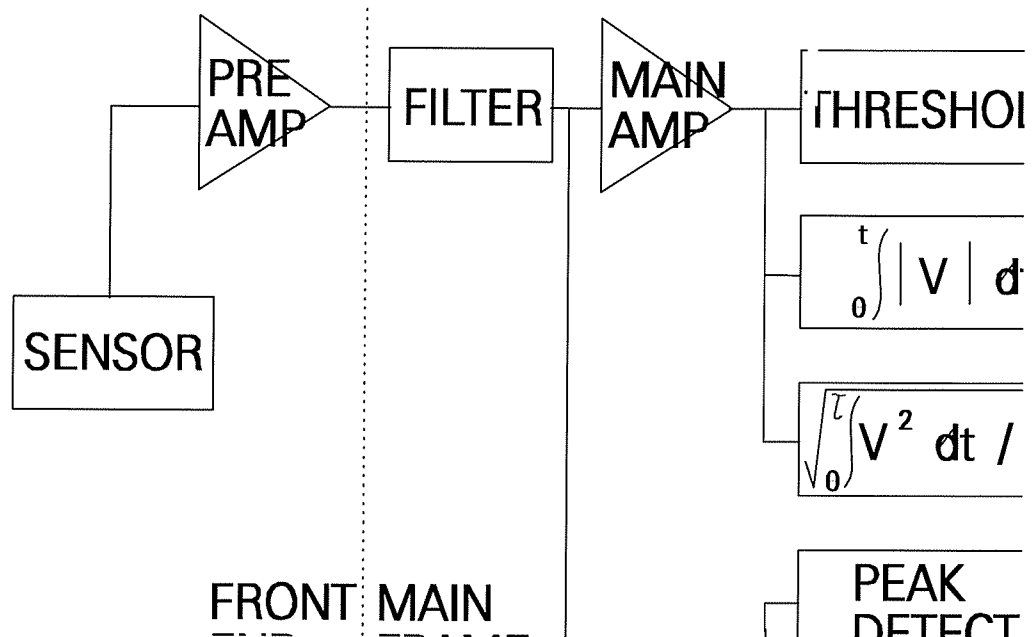

FIGURE 10-15 Signal measurement block diagram.

In hit-based architecture, the system remains dormant until a signal is detected by the threshold circuitry, as discussed in Section 2.5.2. The signal is measured and a microprocessor stores a data record containing the time of detection and the results of the measurements made. After this, the measurement circuitry is reset, ready for the next hit. Thus, the information passed to the computer consists of a series of "hit data sets." Each hit data set takes up typically 30 bytes of storage space. Ideally, each hit data set will correspond to the detection of one AE event (e.g., microscopic crack jump) in the stressed material of the structure under test. The test data builds up in computer memory, or is converted into displays or written to disk or some other medium according to the system design. Environmental data such as pressure, force, displacement, etc., may also be measured at the same time, and the results may be written along with the signal data.

From these data received, the computer can generate many different kinds of displays, both during data acquisition and also at any time afterward by replay of data files written to a disk or other storage medium. Representative architecture for a hit-based system is shown in Figure 10-16. This diagram shows a channel with amplification, filtering, detection, measurement of signal features, and the transfer of data and timing information to data storage and processing circuitry.

A major advantage of hit-based architecture is that it delivers a very detailed description of the emission while making very economical use of data storage space. The storing of hit data sets optimizes the use of storage media and gives the greatest scope for data interpretation and evaluation. The data may be retrieved weeks or even years later for evaluation. The test record is available in the same form as the day it was stored. The permanence of the data record and its ready availability for reanalysis is one of the true advantages, not only of this particular architecture but also of AE testing as a whole.

Hit-based architecture is aimed at comprehensive data acquisition and versatile analysis capability. There are other kinds of architecture with different goals, as well as variations within the broad class of hit-based architecture. Some instruments sacrifice perform-

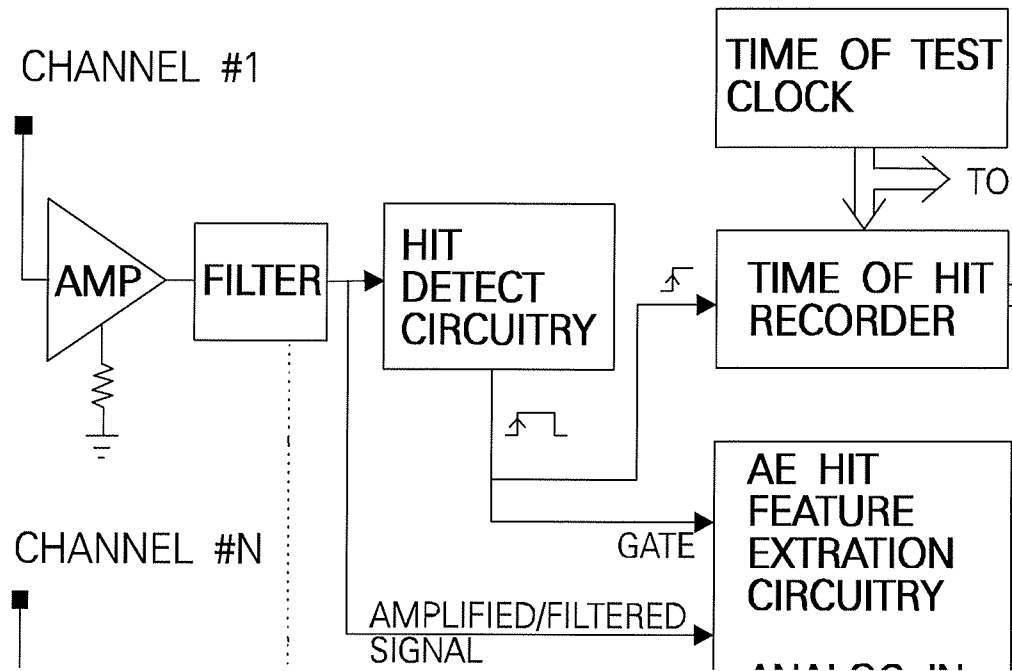

FIGURE 10-16 Instrument functional diagram.

ance in favor of portability. Some systems sacrifice versatility in favor of automatic operation optimized for specific applications. There are simple systems that accumulate AE energy or counts in hardware counters and output a corresponding voltage for plotting on a chart-type recorder. There are dedicated industrial instruments in which the computer prints a predefined set of graphs showing various aspects of the AE data but does not produce a permanent record of every hit. Instruments exist with special alarms or interpretive software. Both research laboratories and commercial vendors have implemented many different AE instrumentation ideas through the years. Out of several hundred diverse AE instrument designs that have been constructed, only a few have been successful enough to warrant production in substantial quantities. A state-of-the-art AE instrument is shown in Figure 10-17. This is a complete digital 52 channel AE system.

## 2.7 Multichannel Source Location Techniques

### 2.7.1 Introduction

AE instrumentation can include many channels. A single AE event can be detected on several channels, producing a hit on each one. These hits will occur in very quick succession, typically all falling within a few hundred microseconds as the wavefront ripples through the sensor array. By comparing the arrival times at different sensors, we can find out about the location of the source. This capability is one of the most useful features of AE testing. When AE is used to inspect a large structure with just a few widely spaced sensors, source location techniques can be used to pinpoint the exact regions that should be inspected later, using other NDT methods.

When AE is used to determine if a known flaw is active, source location techniques can be critical in enabling the user to discriminate successfully between the known flaw

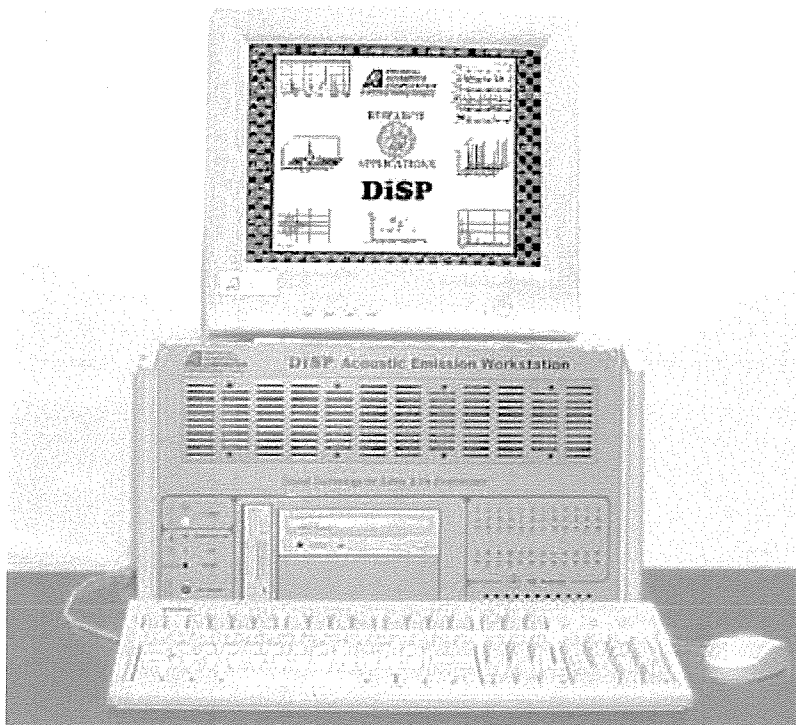
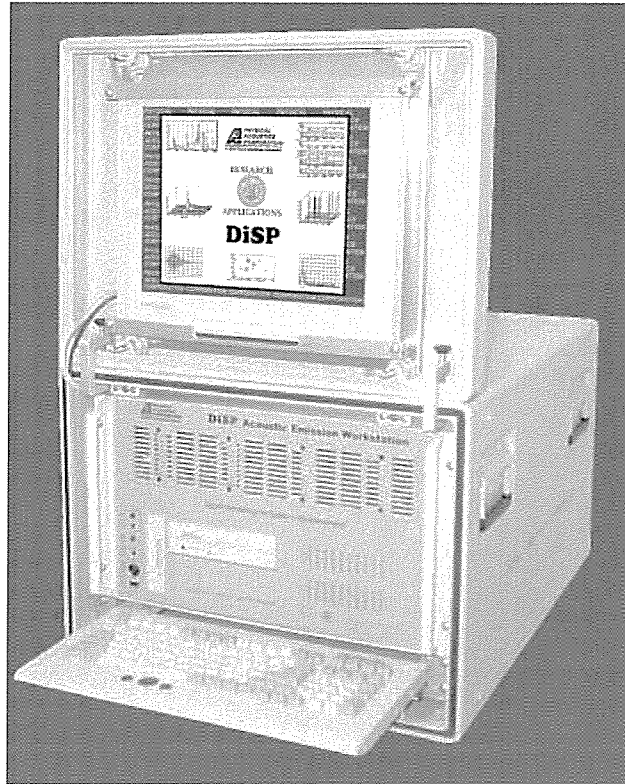

FIGURE 10-17 State-of-the-art acoustic emission system.

and extraneous noise sources. Figure 10-18 shows more details of the basic concept. As the wave spreads out from the source, it reaches first the nearest sensor, S2, then the farther sensors, S3 and S1. As the resulting signals cross the detection thresholds on each channel, “hits” are produced on the corresponding channels in the measurement instrument. The first hit, on sensor S2, occurs at time  $r_2/c$  after the source event, where  $r$  is the distance from source to sensor and  $c$  is the wave velocity discussed in Section 2.4.2. The second and third hits occur at times  $r_3/c$  and  $r_1/c$  after the source event, respectively. Note that the instrument has no direct awareness of the time of the source event. It can measure only the times of the resulting hits; but from the differences between those hit times, it can calculate both the location and the time of the source event.

There are a variety of practical techniques derived from this general concept. The intention might be to focus on one or more predefined areas of interest, to discriminate against one or more predefined noise sources, or to set about the test without preconceptions and take an approach using a location-type overview of all sources on the entire structure. There are techniques based on computation from measured time differences and there are also simplified techniques that only consider the sequence of the hits, without even measuring the actual time differences. There are also techniques based on two, three, four, or more sensors with computations oriented to linear, planar, solid, and complex structural geometries.

With AE instruments, techniques are executed sometimes in hardware, sometimes in acquisition-time software or posttest software, and sometimes according to the user’s choice. Three major approaches—computed source location, zone location, and guard techniques—are explained in the sections below.

### 2.7.2 Computed Source Location

Two of the most widely used location techniques are known as linear location and planar location. The principle of linear location is illustrated in Figure 10-19, which shows the time of arrival difference as a function of the source position. When the source is at the midpoint, the wave arrives at sensors S1 and S2 simultaneously and the time of arrival difference is zero:

$$\Delta T = 0$$

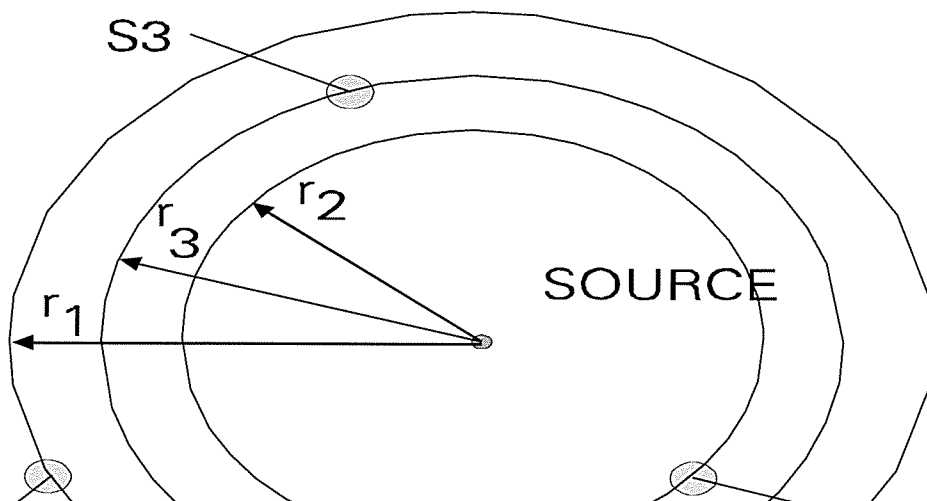

FIGURE 10-18 Basic principle of AE source location.

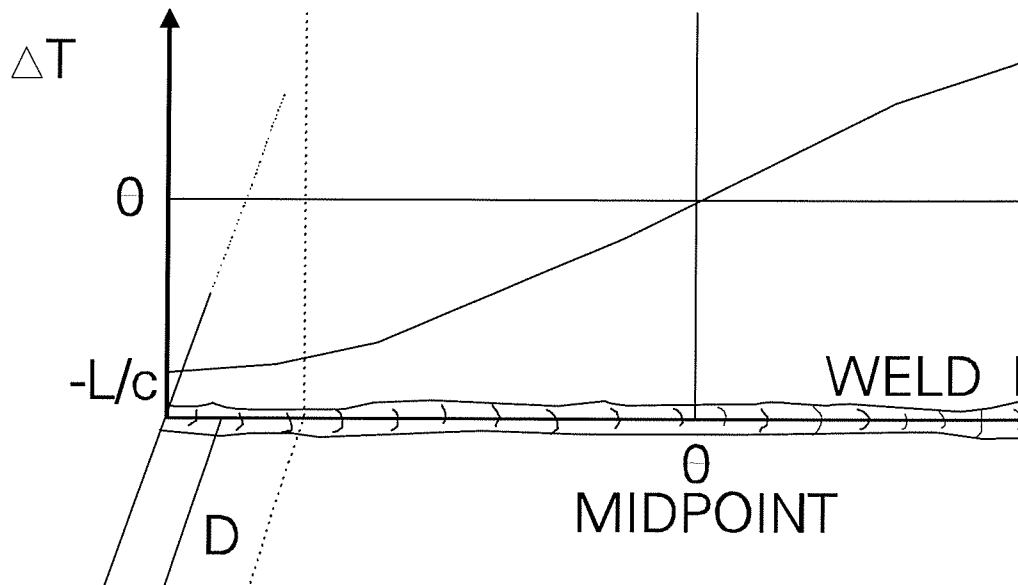

FIGURE 10-19 Principle of linear location.

$\Delta T$  ("delta T") is the algebraic symbol that stands for the time difference between hits. The greater the distance between the source and the midpoint, the greater the delta T. The relationship is linear:

$$\Delta T = \frac{2X}{c}$$

Where  $X$  is the distance of the source from the midpoint, and  $c$  is the velocity of sound discussed in Section 2.4.2. This relationship holds so long as the source is between the sensors. However, if the source is beyond one of the sensors, the delta T has a constant value of  $L/c$ , where  $L$  is the distance between sensors. Thus, a source between the sensors can be pinpointed, but not a source beyond a sensor. Note also in the above equation that an accurate calculation of the source location requires both an accurate measurement of the delta T, and an accurate knowledge of the wave velocity  $c$ . If the delta T differs from true because of some accident of wave propagation, the calculated location will be in error.

If it is desired to use two sensors to locate sources along a weld in a plate but the sensors are offset a distance  $D$  from the weld line, a situation results as is depicted in Figure 10-20. The relationship between source position and delta T is quite similar to the one shown in Figure 10-19 but the straight lines have become curves because the sensors are offset from the weld line.

In this case, it is possible, in principle, to pinpoint a location on the weld line beyond the sensors as well as between them. The greater slope of the curve in the region between the sensors indicates that the technique will be most accurate and reliable in the central region. Beyond the sensors, a small change (or error) in the measured delta T produces a large change (or error) in the calculated source position. In other words, the technique is not as reliable.

The examples in Figures 10-19 and 10-20 illustrate how, with two sensors (one delta T), it is possible to locate the  $X$  position of a source along a line. With three sensors, (two

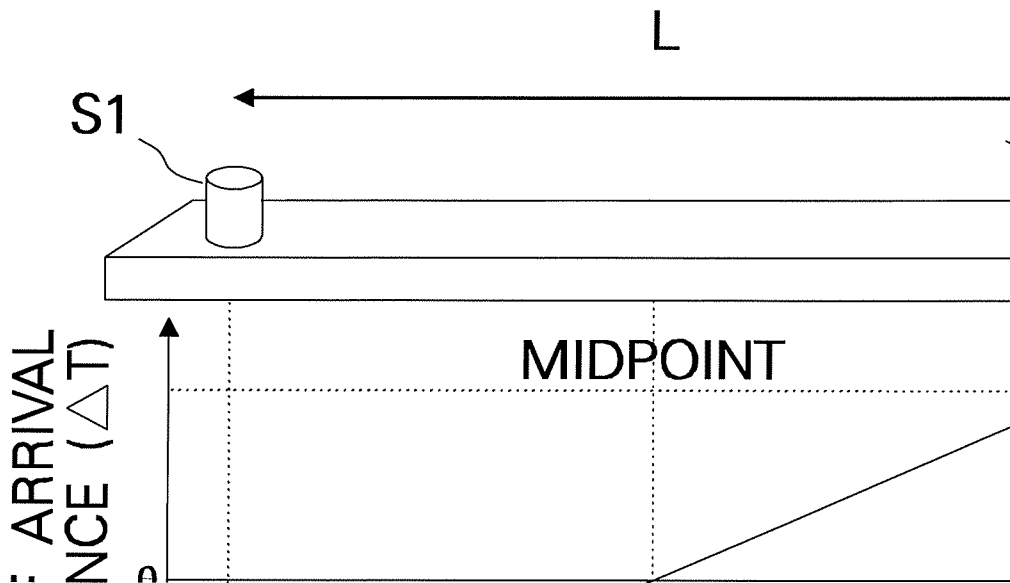

FIGURE 10-20 Source location with two sensors offset from a weld line.

delta T's), it is possible to locate the X and Y positions of a source on a plane. This is the situation illustrated in Figure 10-18. There are many mathematical approaches to source location on a plane, some using three sensors and some using four sensors.

Just as with linear location, the best accuracy for planar location is achieved when the source is well within the sensor array, rather than outside of it. In fact, with only three sensors on a plane, the source location mathematics is ambiguous over most of the plane. For many points outside the triangle, it is possible to find matching points inside the triangle that will produce the same delta T's. The resulting regions of ambiguous location are shown in Figure 10-21 for an array of three sensors in an equilateral triangle.

Location tends to be ambiguous when the first arrival occurs long before either of the other arrivals. When a three-sensor array is used for monitoring a specific area of interest, it is clearly important to place the area of interest in the area of unique location, not in the area of ambiguous location. Alternatively, the problem of ambiguous location can be resolved by the use of an extra delta T from a fourth sensor.

There are many mathematical techniques for accomplishing source location on a plane. Some use three sensors and some use four. Several exact analytical solutions have been described, some slow and clumsy, some fast and sophisticated. Approximation solutions have also been widely used. These can offer a good combination of speed, accuracy, and robustness when faced with the option of inferior data. These include iterative approaches, least-squares solutions, and linear and quadratic approximations.

The accuracy of the computed source location is limited more by wave propagation factors than by the mathematical approaches. The conventional approaches all assume that the wave travels directly from source to sensor with a well-defined velocity. In practice, reflections, multiple wave modes, and other propagation effects that produce uncertainties in the effective velocity, as well as scatter in the experimental data, can upset this assumption. The result is that computed source location using conventional approaches is very accurate in some situations but prone to serious error in others. Structural geometry and operating frequency govern whether conventional source location techniques will work well or not.



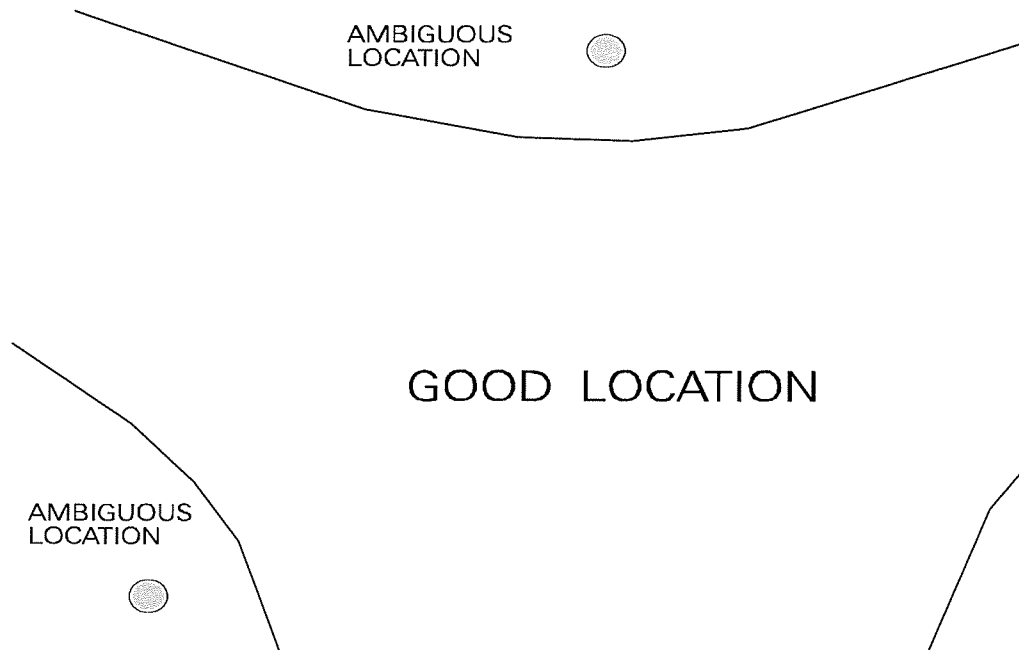

FIGURE 10-21 Good location and ambiguous location with a three-sensor array.

With computed source location, several hits are needed or there can be no computation. Smaller events that only hit one sensor are liable to be ignored. This can be dangerous, especially in wide-area monitoring. Overreliance on computed source location has sometimes led users to ignore important data and to draw the wrong conclusions about structural integrity. Therefore, computed source location must be used wisely. The sensor spacing must be properly adapted to the wave attenuation on the particular structure being monitored, and to the desired sensitivity.

### 2.7.3 Zone Location and Guard Techniques

A simpler type of source location is known as zone location. Here, conclusions are drawn from the hit sequence alone, without actually measuring the delta T's. This development began with the idea of guard sensors, which is illustrated in Figure 10-22. The technique was conceived in the early 1960s as a way to record data from a limited area of interest, while rejecting noise from outside.

A "data" sensor D is placed on the area of interest surrounded by several guard sensors G. AE waves from the area of interest will hit the data sensor before hitting any of the guards. Waves from outside will hit at least one of the guards before hitting the data sensor. Based on this, it is easy to reject the outside noise. The concept can be implemented in several different ways. Sometimes this process is conditioned by hardware circuitry in the instrument or by software between the detecting and the recording of the hits. In these cases, the noise signals are not recorded. Sometimes this process is performed by posttest analysis on systems that record all hits, including hits on guards. Posttest processing is safer, but the files are longer and more work is necessary during the analysis of the data. As a variant on the guard sensor technique, guard sensors can be placed on known noise sources and data sensors can be placed around the rest of the inspection area.

The idea of first-hit zone location was a further development of the guard concept,

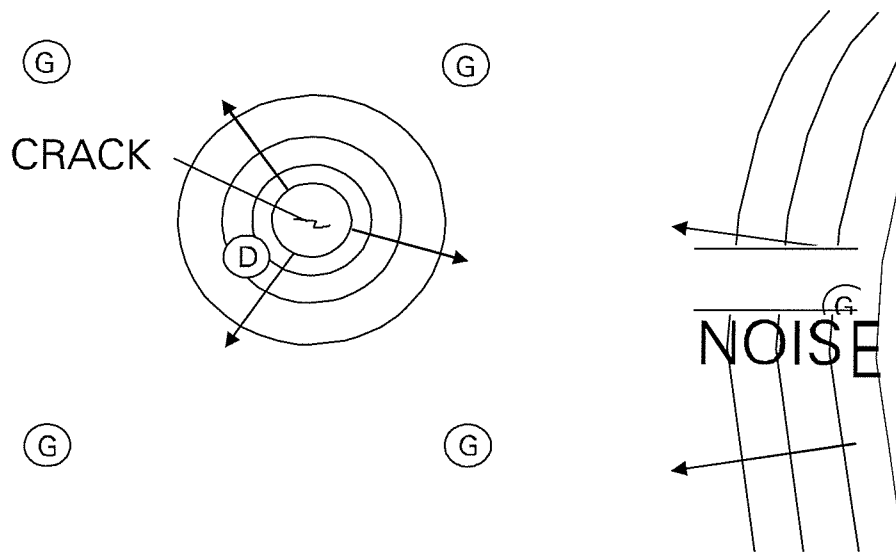

FIGURE 10-22 Guard sensor concept.

conceived in 1972. This is a technique for wide-area monitoring. Many sensors monitor the inspection area, and a determination is made as to which channel detects the wave first. If the wave is traveling uniformly, the first-hit sensor must be closer to the source than any other sensor. By paying attention to the first hit sensor, good information is gained about the location of the source.

With first-hit zone location, the inspection area can be divided into zones, each zone being centered on one sensor. If a particular sensor is the first one to be hit, it can be concluded that the source lies somewhere in that sensor's zone.

Figure 10-23 shows the pattern of zones for a simple layout of sensors on a plane. The zone boundaries are straight lines that evenly divide the spaces between pairs of sensors. In geometric terms, they are the perpendicular bisectors of the lines joining neighboring sensors. Figure 10-24 shows the expansion of this concept into the three-dimensional structure.

Data from structural tests is often displayed by channel, e.g., a graph of hits versus channel or a graph of a particular channel's activity. The practical value of first-hit zone location is that it allows the user to remove second-hit and third-hit information from the data, so that each channel shows only the emission that actually originated within its zone. This substantially sharpens and cleans up the data.

As with the guard technique, the first-hit zone location technique can be implemented by hardware circuitry, by software at the time of data acquisition, or by software during posttest analysis. Details of the implementation differ depending on the specific instrument design.

Zone location can be extended to take into account the second and third hits, if there are any. With the knowledge of the channel that received the second hit, the source location can be narrowed down to a small segment of the primary zone. With the knowledge of the channel that received the third hit, the source location can be narrowed down still further. However, these techniques are seldom implemented.

A benefit of the zone location approach is that only a single hit is needed for the event to be admitted into the analysis process. In the preceding discussion of computed source

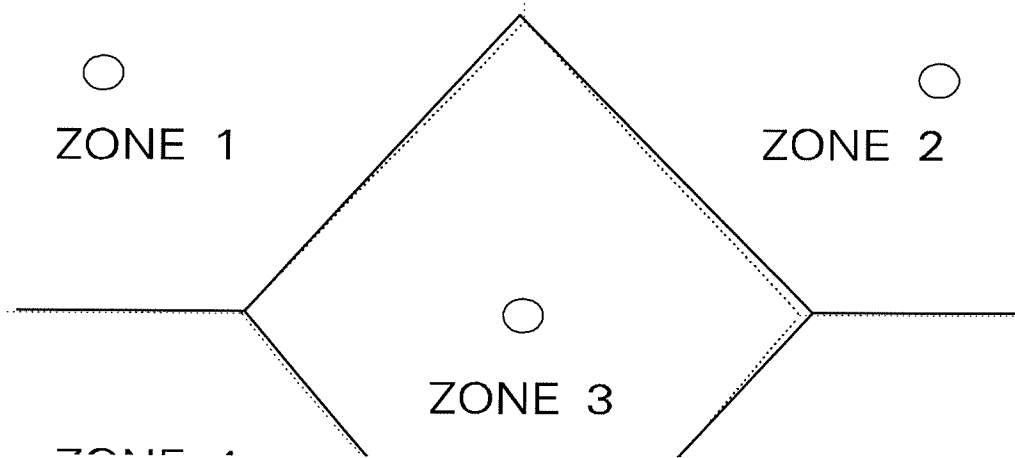

FIGURE 10-23 First-hit zone location.

location, it was pointed out that several hits are needed to give the delta T's required for computation. Compared with this, zone location has, in effect, a higher sensitivity and none of the detected events are ignored.

## 2.8 Data Displays

Becoming familiar with the AE data displays and learning how to read them is a very important part of the AE user's training. Even those who are familiar with other NDT meth-

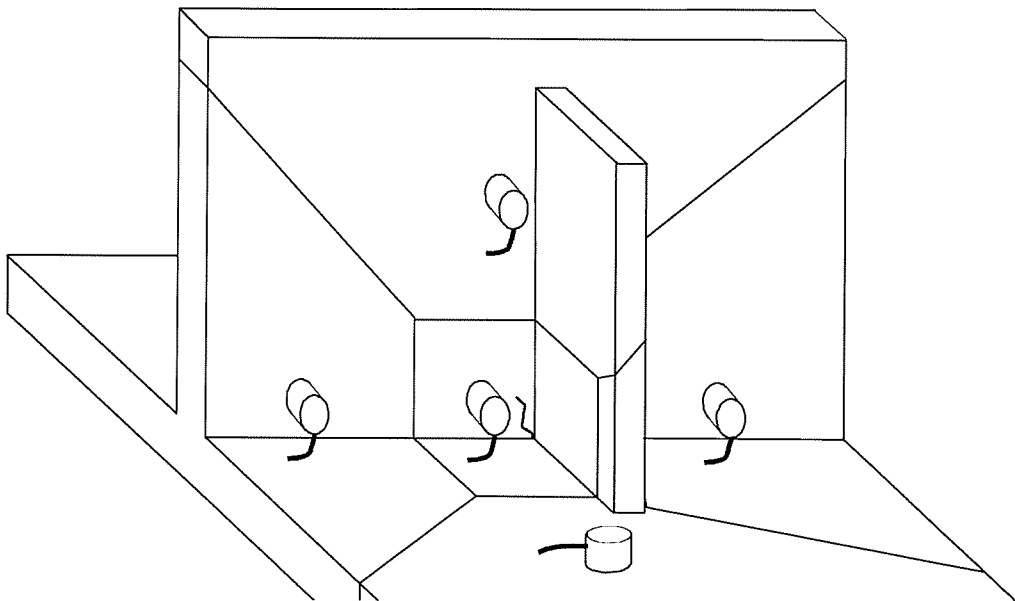

FIGURE 10-24 Zone location on a structure.

ods may find AE displays strange at first because they are basically graphs of numerical data, rather than the visual images and displays that are the working tools of some other NDT methods.

AE data displays can be grouped into four categories:

1. Location displays
2. Activity displays
3. Intensity displays
4. Data quality (crossplot) displays

Location displays are widely used. However, other kinds of displays are very valuable for background information on-site, for investigative work, and for data analysis, especially in the more difficult situations. Therefore, with training and practice, the AE practitioner becomes familiar with all the display types. Location displays show where the emission is coming from. When computed location techniques are being used, the typical location display is a map of the inspection area. An example is shown in Figure 10-25. The user defines the X-Y coordinate frame for the map as the software is set up. The sensor numbers are shown in the appropriate places on the map. When planar source location is being used, the location of each event is plotted as a dot on the map. If a source emits repeatedly, the dots form a cluster, as shown in Figure 10-25. The user's eye is drawn naturally to the clusters on the screen that correspond to the most emissive sources.

When linear location is being used, the display is a histogram with the span between the sensors laid out along the X axis. This is illustrated in Figure 10-26. The X axis is divided into a number of segments or "bins," typically 100. Each located event is assigned to the bin that corresponds to its location. The number of events in each bin is indicated by the height of the histogram bar. When viewing this display, the user's eye is drawn to the highest peak or the highest concentration of indications. This is where the majority of the emission activity originates.

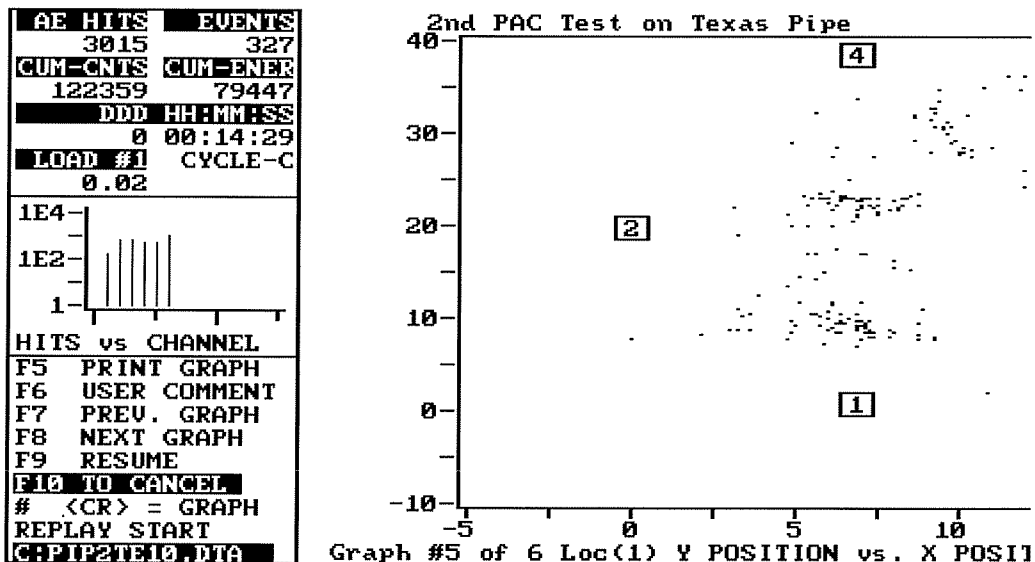

FIGURE 10-25 Planar source location display.

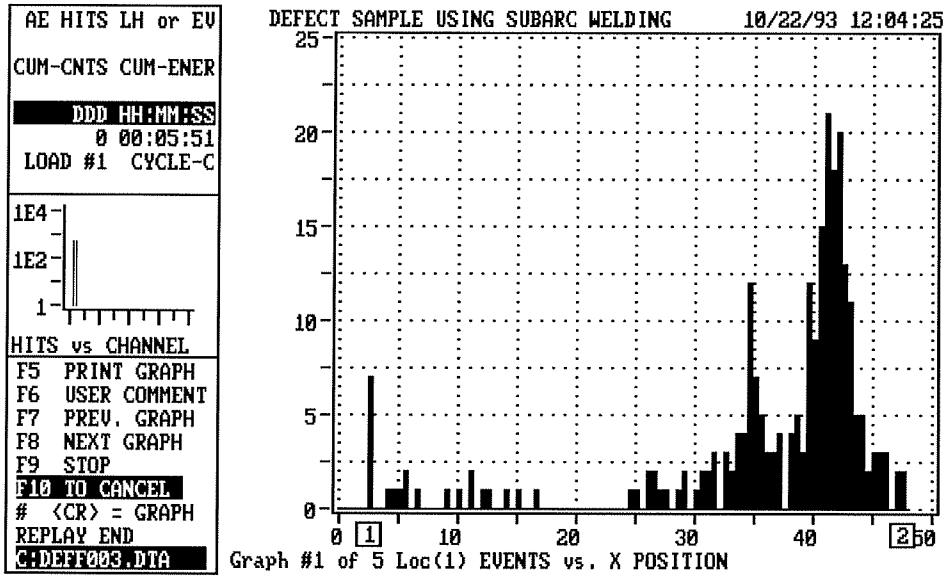

FIGURE 10-26 Linear location display.

A third kind of location display is a histogram of events as related to channels. This is used for first hit zone location, where each event is assigned to the channel that detected it first, and later hits on other channels are disregarded. This type of display is illustrated in Figure 10-27. The height of the bar for each of the five channels shows the number of events detected by that channel first. Channel 4 shows the most activity, with 1700 events hitting it first in one hour of monitoring. In this case, the crack was between channels 1 and 2; channels 3, 4, and 5 were guard sensors used to screen out extraneous noise.

There are variations on the display shown in Figure 10-27. For example, the total AE signal energy from each zone could be plotted on the Y axis instead of the total number of events. This would provide greater prominence to the zones that produced high-energy

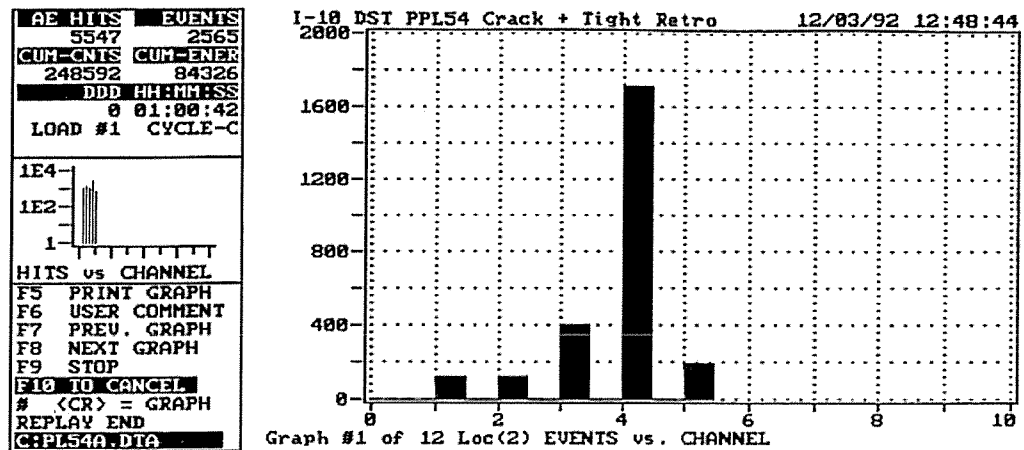

FIGURE 10-27 Zone location display.

hits. The second major class of displays is activity displays. These include displays that have time on the X axis (see Figure 10-28). The displays show when the AE activity occurred and how much activity there was. As in Figure 10-26, the X axis is divided into bins. In this example, there are 100 bins from left to right, so each bin represents a time slice of 36 seconds. On the Y axis, the height of each histogram bar shows how much emission occurred during that time slice. As shown, there typically are detected hits, located events, or total energy shown. In older reports the Y axis often showed AE counts, i.e., threshold crossing counts, as shown in Figure 10-14.

The Y axis scaling can be linear, as in Figure 10-28, or logarithmic, as in Figure 10-29. Looking at the linear plot, a few time slices with very high activity stand out prominently from a low-level background.

In the logarithmic plot, the scaling reduces the visual impact of these very active time slices, but provides more information about the fluctuating lower-level activity in between. In the logarithmic Y axis scaling of Figure 10-29,  $1E1$  stands for  $10^1$  which is 10,  $1E2$  stands for  $10^2$ , which is 100,  $1E3$  stands for  $10^3$ , which is 1000, and so on.  $1E^0$  stands for 1. Logarithmic axes can cover a large span. A 24-hour logarithmic plot would allow comparison in the same glance of large amounts of AE produced in "rush-hour traffic" and a very small amount produced in the "middle of the night." With linear axes, very small amounts may not even show above the baseline.

In becoming familiar with logarithmic plots, it is important to learn how to read the scale and how to interpret the display. In the lower part of the display, the patterns of rising and falling activity may be informative, but it must always be remembered that the actual level is low. In the upper part of the display, the level of activity is drastically greater and even a small increase in the height of the histogram bar means thousands of additional emissions detected.

Another form of activity display is shown in Figure 10-30. Instead of showing the amount of activity in each time slice, this display shows a running total of all the activity detected since the start of the test. This is the best display for measuring the average emission rate as well as for observing the total emission quantity.

The third major class of displays is "intensity displays." These provide statistical information about the size of the detected signals. In many cases, large signals are likely to

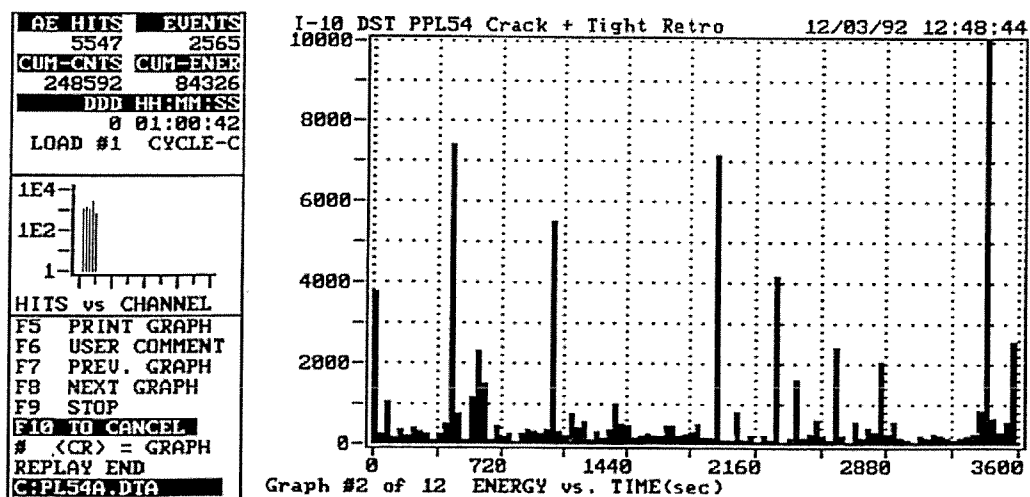

FIGURE 10-28 Activity display: AE rate versus time.

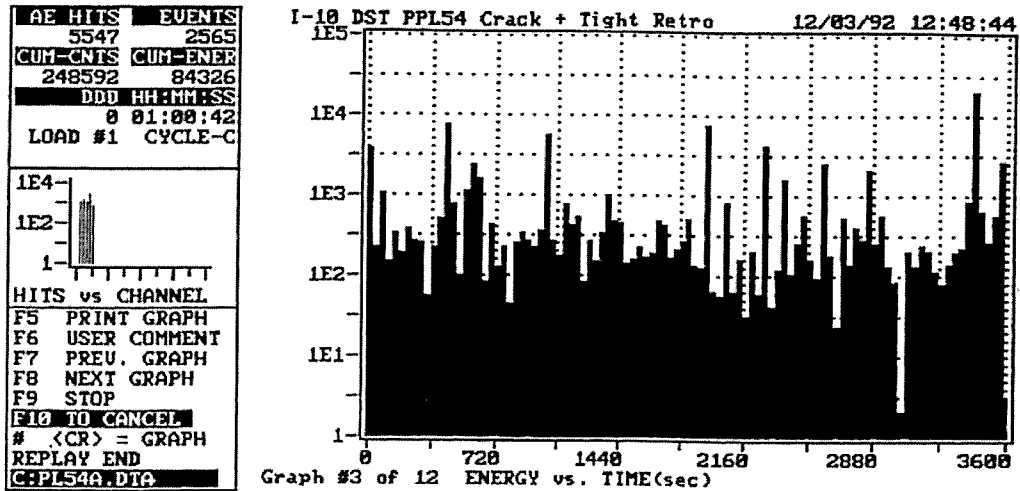

FIGURE 10-29 Activity versus time, logarithmic scale.

be more important than small signals. Furthermore, a given total amount of AE signal energy might be originating from a few large signals or from many small signals; it could be important to know about these origins. These are the issues that are addressed by intensity displays.

The best-known intensity display is the “amplitude distribution” plot, which shows how many of the hits were large and how many were small. This display exists in two forms. The “differential” form, illustrated in Figure 10-31, is a histogram with amplitude on the X axis. The X axis is divided into a hundred 1 dB slices. The heights of the bars

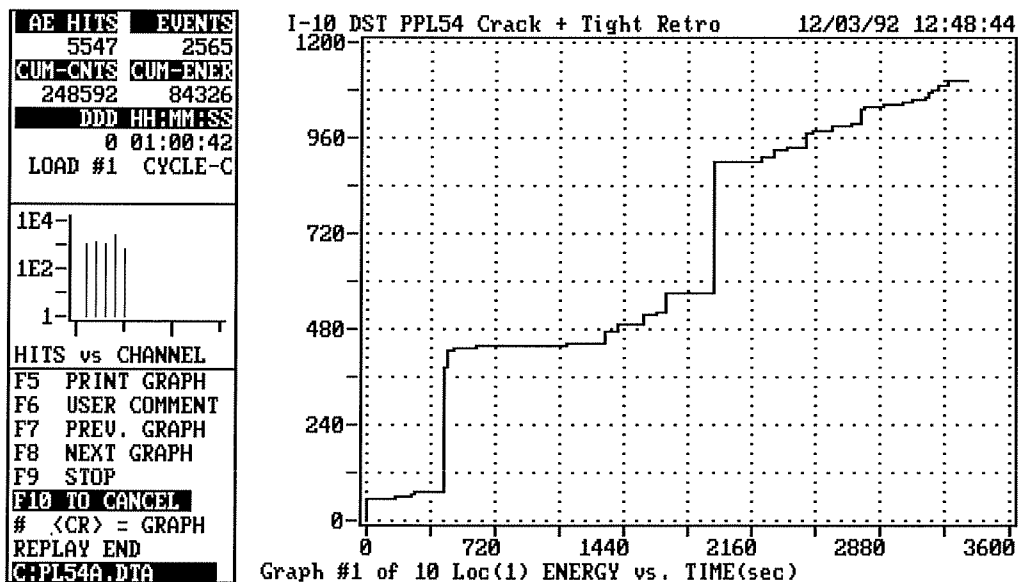

FIGURE 10-30 Cumulative activity display.

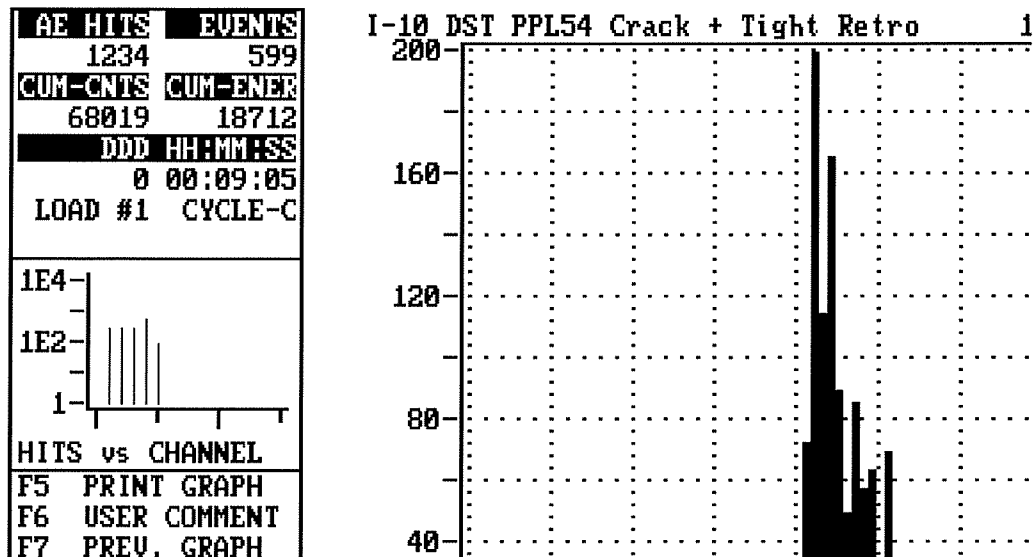

FIGURE 10-31 Differential amplitude distribution.

show how many hits were recorded at each 1dB level. Typically, there are many low-amplitude signals and fewer high-amplitude signals. Naturally, there are no measured signals with amplitudes less than the detection threshold, so the display is blank to the left of the threshold dB value.

The cumulative form of the amplitude distribution display is a line graph, presenting the number of hits that were greater than the X axis amplitude. This form is derived from the differential display by scanning it from right to left and accumulating the contents of the bins. The cumulative display derived from Figure 10-31 is shown in Figure 10-32. Both differential and cumulative forms are often displayed with a logarithmic scale on the Y axis. This makes it easier to assess the high-amplitude activity even when the low-amplitude hits are much more numerous.

The shapes of the amplitude distributions often give valuable clues about the source mechanisms that are producing them. For example, growing cracks often give straight lines when a logarithmic scale is used on the Y axis. If the plot is far from linear, it is probably not a growing crack. Figure 10-32 is a typical example of a straight-line amplitude distribution. Another type of intensity display is the so-called "energy account," illustrated in Figure 10-33. This shows whether the total signal energy is coming mostly from low-energy events or mostly from high-energy events. The X axis shows the energy of the individual hits, on a logarithmic scale from 1 to 100,000, divided into 50 bins. The height of each bar shows the total energy from all the hits that fall into that bin.

Different emission source mechanisms cause amplitude distributions and energy accounts to show as different shapes. These displays can help to identify the mechanisms that are working, and can help to tell the difference between flaw-related AE and extraneous noise. The fourth and last major class of AE displays is crossplot displays. These are used during interpretation to assess data quality. The term "crossplot" implies a plot in which each hit gives one point on the display, showing the cross-relationship between two measured signal features. The best-established crossplots are "duration versus amplitude," "counts versus amplitude," and "counts versus duration." A duration/amplitude crossplot is illustrated in Figure 10-34.



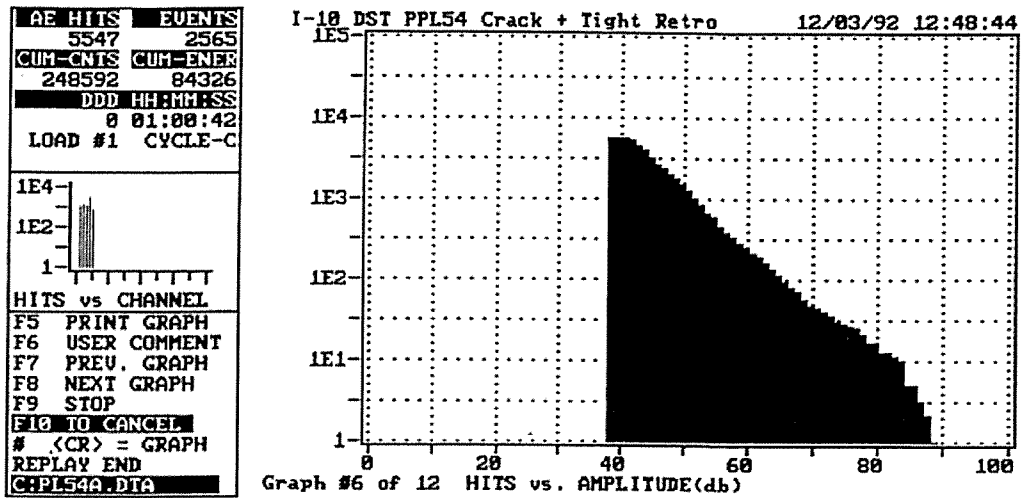

FIGURE 10-32 Cumulative amplitude distribution.

Larger signals typically have higher amplitudes and also more counts (see Figure 10-14). Therefore, the data in the counts/amplitude crossplot tend to fall into a diagonal band running from lower left to upper right. Along with this basic tendency there are subtle variations that can provide additional information about the shape of the signal. Shape, in turn, depends on the source mechanism.

Short, sharp sources, such as crack growth, cause short-rise, quick-decay signals, whereas long, drawn-out source processes, such as frictional sliding, show as slow-rise, slow-decay signals. This is indicated in Figure 10-35.

A crack-growth signal and a friction signal might have the same amplitude, but the

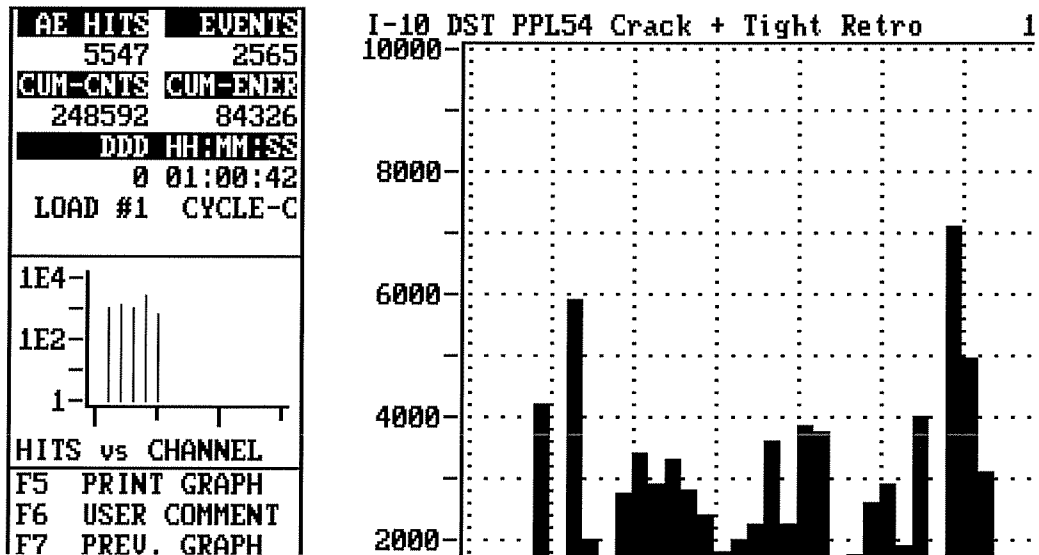

FIGURE 10-33 Energy account.

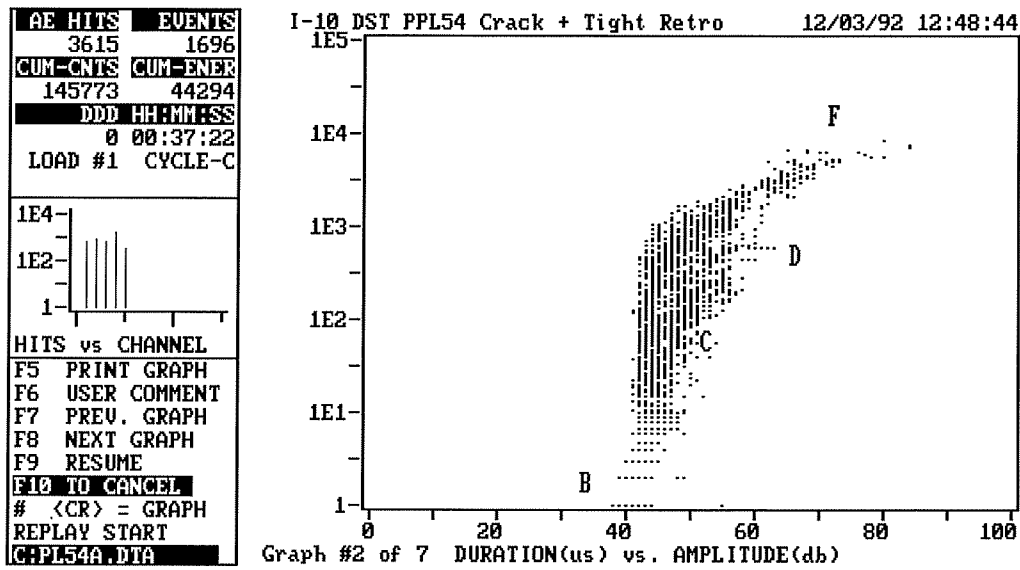

FIGURE 10-34 Duration/amplitude crossplot.

friction signal would have a much longer duration. This provides a technique for recognizing signals from friction and distinguishing them from signals originating from crack growth. Figure 10-34 shows three distinct bands of data. There is a large, broad band at the top, a short, tight band at the bottom, and a third lying in between. These bands correspond to different signal shapes. Signal shape is influenced not only by source mechanism but also by wave propagation, so the analysis of this kind of data is quite demanding. It is not immediately obvious whether the different bands correspond to different channels, to different source locations, or to different source mechanisms. Various techniques of advanced data analysis and signal processing can be used to address these issues.

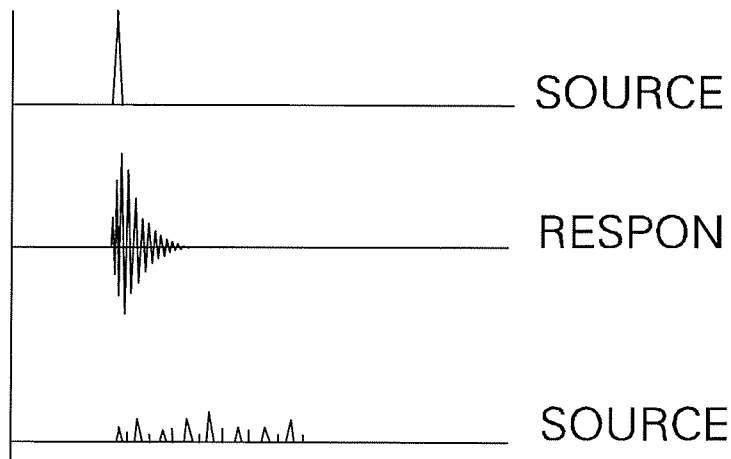

FIGURE 10-35 Signal shapes depend on source mechanism.

## 2.9 Interpretation and Evaluation

In nondestructive testing, data interpretation and evaluation proceed as shown in Figure 10-36. ASTM has developed the following definitions:

*Indication.* Response or evidence of a response in a nondestructive test.

*Interpretation.* The determination of whether indications are relevant, nonrelevant, or false.

*Evaluation.* The determination of the significance of relevant indications.

*False* (referring to an indication). Obtained through improper technique or processing.

In AE testing, the most basic kind of indication is simply a hit (the data record produced after the signal has crossed the threshold). Relevant indications are hits produced by the crack. Nonrelevant indications include hits produced by sources outside the inspection area. False indications include hits due to “echoes,” which can occur if the instrument is badly set up.

In AE as in all other NDT methods, interpretation occurs before evaluation. Sometimes, interpretation is performed explicitly and deliberately, as a well-defined step in a documented data analysis process. In other instances, interpretation is made more implicitly and seems little more than a common-sense effort to extract the most out of the available data.

When conducted explicitly, the first task in data analysis is to identify any nonrelevant and false indications in the data file, and then to filter them out. A new data file is written that contains only the relevant data, and running this filtered file through an evaluation program performs the evaluation. This process is used in several AE applications where the techniques have been standardized and a clear-cut procedure has been written. A good example is the AE testing of railroad tank cars. In this and other applications, the duration–amplitude crossplot shown in Figure 10-34 is a key tool in the interpretation process. The use of this crossplot can be included as part of a well-defined procedure, and technicians using it have a common understanding and basis for discussion, refinement, and ongoing development.

Evaluation procedures have been codified for several major AE applications. The best way to arrive at documentable evaluation procedures is to obtain a broad and representa-

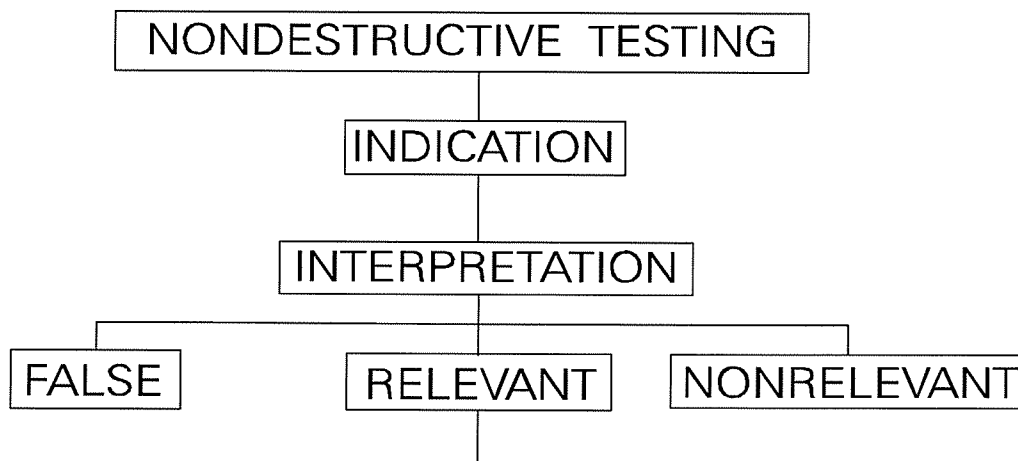

FIGURE 10-36 Interpretation and evaluation of NDT data.

tive range of field experience, following up the AE tests with other NDT inspections to characterize the flaw conditions as thoroughly as possible. By documenting conditions and results with the use of a database, data can be accumulated for use in future analyses. This has been done for several leading AE applications, such as pressure vessels and tanks, railroad tank cars, jumbo tube trailers, and aircraft fuselages.

Evaluation sometimes hinges on located clusters of events, sometimes on total emission quantities, and sometimes on emission in specific parts of the test, such as high-stress load holds. Often, the data is evaluated in accordance with several applicable acceptance criteria. Comparison of AE data with specific acceptance criteria serves as a screening process. If the structure meets the acceptance criteria, it is deemed acceptable. If not, the procedure specifies either another stage of AE data analysis or verification of the AE data with other nondestructive testing methods.

In less standardized applications, interpretation and evaluation are often conducted more implicitly. In interpretation, the technician uses commonsense observations to remove false indications (noise), or to focus on the parts of the test that are determined to contain the most meaningful information. The final evaluation tends to emerge from a personal blending of data analysis with the experience, commonsense observation and technical intuition. These can be subjective processes and the degree of success depends very much on the skills of the individual technician. These skills are difficult to teach and communicate, and the processes actually used by an individual will change over the years as interests and preferences shift and as new ideas are considered. This style of operation is best seen as a necessary prelude to the development of standardized procedures that can be used widely and reliably.

Evaluation criteria are only meaningful when they are related to a specific instrumentation setup and a specific load stimulus. In testing pressure vessels, tanks, etc., the load stimulus can be numerically specified, controlled, and measured by the technician.

### **3. ADVANTAGES AND LIMITATIONS OF ACOUSTIC EMISSION TESTING**

---

In contrast with most other NDT methods, in AE testing the discontinuity itself is the releaser of energy, making its own signal (in response to *stress*). AE testing detects *movement* (other methods detect *geometric discontinuities*).

*Advantages of AE testing:*

- AE can be used in all stages of testing including:
  - Preservice (proof) testing
  - Inservice (requalification) testing
  - On-line monitoring of components and systems
  - Leak detection and location
  - In-process weld monitoring
  - Mechanical property testing and characterization
- Material anisotropy is good
- (Less) geometry sensitive
- Less intrusive
- Global monitoring

- Real-time evaluation
- Remote scanning
- Performance/price ratio

*Limitations of AE testing:*

- Repeatability: Acoustic emission is stress unique and each loading is different.
- Attenuation: The structure under test will attenuate the acoustic stress wave.
- History: Tests are best performed if the loading history of a structure is known.
- Noise: Acoustic Emission can be subject to extraneous noise.

The advantages and disadvantages of AE testing can be summarized as in the following table:

Acoustic emission	Most other NDT methods
Discontinuity growth/movement	Discontinuity presence
Stress, damage-related	Shape-related
Material anisotropy is good	Material anisotropy is bad
(Less) geometry sensitive	(More) geometry sensitive
Each loading is unique	Inspections are readily repeated
Less intrusive	More intrusive
Global monitoring	Local scanning
Principal limitations: attenuation, history dependence, and noise	Principal limitations: access, geometry, and dependence on discontinuity orientation and proximity to surface

#### **4. GLOSSARY OF ACOUSTIC EMISSION TERMS**

This glossary is presented in two forms. First, selected key terms are listed in logical order to show how standard terminology is used to describe the AE process from source to data storage. Second, a more complete glossary is presented in alphabetical order. Definitions for items marked with an asterisk are drawn from ASTM E 1316, and in some cases, reflect minor changes.

##### **Key Terms in Logical Order**

**Acoustic emission (AE)**—elastic waves generated by the rapid release of energy from sources within a material.

**Event (AE)**—a local material change giving rise to acoustic emission.\*

**Source**—the physical origin of one or more AE events.

**Sensor**—a device containing a transducing element that turns AE wave motion into an electrical voltage.

**Signal**—the electrical signal coming from the transducing element and passing through the subsequent signal conditioning equipment (amplifiers, frequency filters).

**Channel**—a single AE sensor and the related equipment components for transmitting, conditioning, detecting, and measuring the signals that come from it.

**Detection**—recognition of the presence of a signal (typically accomplished by the signal crossing a detection threshold).

**Hit**—the process of detecting and measuring an AE signal on a channel.

**Signal features**—Measurable characteristics of the AE signal, such as amplitude, AE signal energy, duration, counts, and risetime.

**Hit Data Set**—the set of numbers representing signal features and other information, stored as a result of a hit.

**Event data set**—the set of numbers used to describe an event, pursuant to data processing that recognizes that a single event can produce more than one hit.

### Terms in Alphabetical Order

**Acoustic emission (AE)**—elastic waves generated by the rapid release of energy from sources within a material.

**Activation (AE)**—the onset of AE due to the application of a stimulus such as force, pressure, heat, etc.

**Activity\* (AE)**—a measure of emission quantity, usually the cumulative energy count, event count, ringdown count, or the rates of change of these quantities.

**Amplitude (AE)**—the largest voltage peak in the AE signal waveform; customarily expressed in decibels relative to 1 microvolt at the preamplifier input ( $\text{dB}_{\text{ae}}$ ).

**Amplitude distribution\***—a display of the number of AE signals at (or greater than) a particular amplitude, plotted as a function of amplitude.

**Attenuation**—loss of amplitude with distance as the wave travels through the test structure.

**Burst emission\***—a qualitative description of the discrete signal related to an individual emission event occurring within the material.

**Channel (AE)**—a single AE sensor and the related equipment components for transmitting, conditioning, detecting, and measuring the signals that come from it.

**Continuous emission\***—a qualitative description of the sustained signal level produced by rapidly occurring acoustic emission events.

**Counts**—the number of times the AE signal crosses the detection threshold. Also known as “ringdown counts” and “threshold crossing counts.”

**$\text{dB}_{\text{ae}}$** —a unit of measurement for AE signal amplitude  $A$ , defined by  $A (\text{dB}_{\text{ae}}) = 20 \log V_p$  where  $V_p$  is the peak signal voltage in microvolts referred to the preamplifier input.

**Detection (AE)**—recognition of the presence of a signal (typically accomplished by the signal crossing a detection threshold).

**Event\* (AE)**—a local material change giving rise to acoustic emission.

**Event data set (AE)**—the set of numbers used to describe an event, pursuant to data processing, that recognizes that a single event can produce more than one hit.

**Event description**—a digital (numerical) description of an event, comprising one or more signal descriptions and/or information extracted from them or calculated from them.

**Event energy\* (AE)**—the total elastic energy (in the wave) released by an acoustic emission event.

**Felicity effect\***—the presence of AE at stress levels below the maximum previously experienced. (The reverse of the Kaiser effect.)

**Frequency**—for an oscillating signal or process, the number of cycles occurring in unit time.

**Guard sensors**—sensors whose primary function is the elimination of extraneous noise based on arrival time differences.

- Hit (AE)**—the detection and measurement of an AE signal on a channel.
- Hit data set**—The set of numbers representing signal features and other information, stored as a result of a hit.
- Intensity\* (AE)**—A measure of the size of the emission signals detected, such as the average amplitude, average AE energy, or average counts.
- Kaiser effect\***—The absence of detectable acoustic emission at a fixed sensitivity level, until previously applied stress levels are exceeded.
- kHz**—Kilohertz, an SI unit of frequency, 1000 cycles per second.
- Location\***—relating to the use of multiple AE Sensors for determining the relative positions of acoustic emission sources.
- Noise**—nonrelevant indications; signals produced by causes other than AE, or by AE sources that are not relevant to the purpose of the test.
- Parametric inputs**—environmental variables (e.g., load, pressure, temperature) that can be measured and stored as part of the AE signal description.
- Risetime**—the time from an AE signal first threshold crossing to its peak.
- Sensor (AE)**—a device containing a transducing element that turns AE wave motion into an electrical voltage.
- Signal (AE)**—the electrical signal coming from the transducing element and passing through the subsequent signal conditioning equipment (amplifiers, frequency filters).
- Signal description**—the result of the hit process: a digital (numerical) description of an AE signal and/or its environmental context.
- Signal features**—measurable characteristics of the AE signal, such as amplitude, AE energy, duration, counts, and risetime, that can be stored as part of the AE signal description.
- Signal strength (AE)**—the strength of the absolute value of a detected AE signal. Also known as “relative energy,” “MARSE,” and “signal strength.”
- Source (AE)**—the physical origin of one or more AE events.
- Source energy (AE)**—the total energy (of all forms) dissipated by the source process.
- (Primary) zone**—the area surrounding a sensor from which AE can be detected and from which AE will strike the sensor before striking any other sensors.

## 5. REFERENCES

---

1. A. A. Pollock, “Inspecting Bridges with Acoustic Emission,” Guidelines prepared for the U.S. Department of Transportation and Federal Highway Administration (FHWA), June 1995. Technical Report No. TR-103-12 6/95. Physical Acoustics Corp., Princeton Junction, NJ 08550.
2. R. K. Miller (Ed.), *Nondestructive Testing Handbook*, 2nd edition, Volume 5 “Acoustic Emission Testing.” 1987. American Society for Nondestructive Testing, Columbus, OH.